



SJ

50Hz/60Hz

Stainless Steel Multistage Deep-Well Submersible Pump



Nanfang Pump Industry Co.,Ltd.

CNP Headquarter
Address: Renhe Town, Hangzhou China
PostCode: 311107
Tel: +86 571 86397810, 86397838
Fax: +86 571 86397809
E-mail: info@nanfang-pump.com
<http://www.cnppump.com>

E121107
subject to amendments



● Performance scope

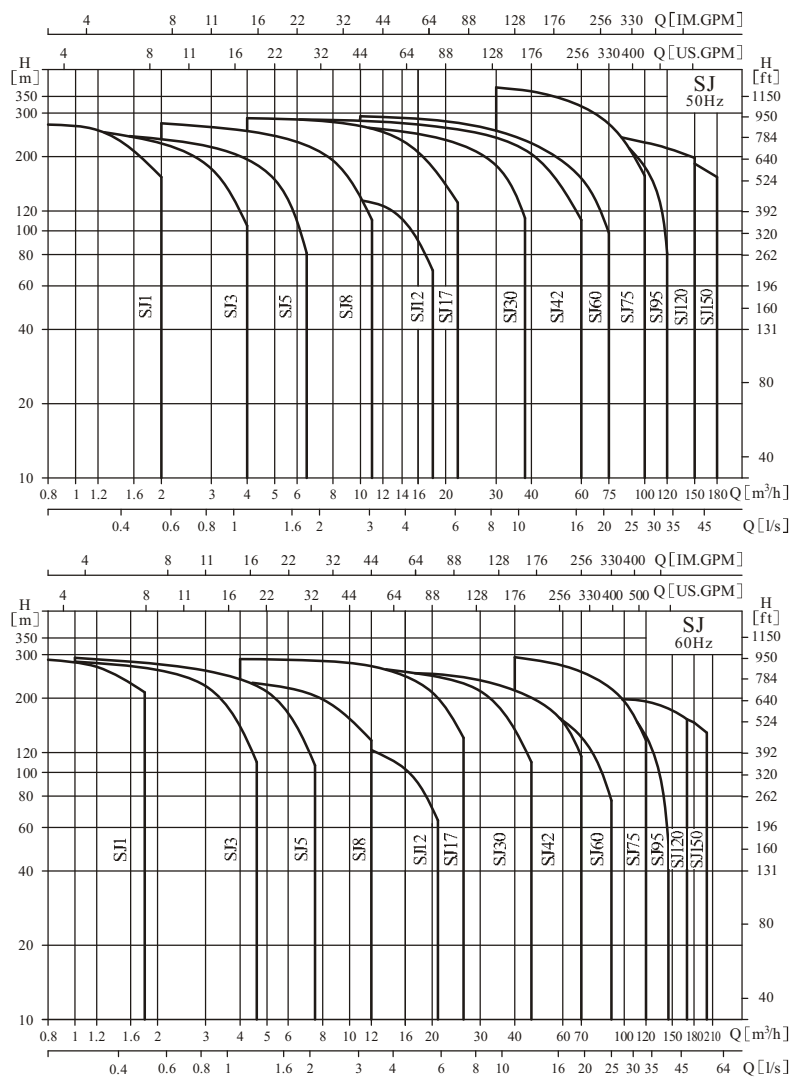

● Product range

Description	SJ1	SJ3	SJ5	SJ8	SJ12	SJ17	SJ30	SJ42	SJ60	SJ75	SJ95	SJ120	SJ150
50Hz													
Rated flow [m³/h]	1	3	5	8	12	17	30	42	60	75	95	120	150
Rated flow [1/s]	0.28	0.83	1.39	2.22	3.33	4.72	8.33	11.7	16.7	20.8	26.4	33.3	41.6
Flow range [m³/h]	0.2~2	0.8~4	1~6.5	2~11	3~18	4~22	5~38	5~60	10~75	30~100	40~120	60~150	80~180
Flow range [1/s]	0.06~0.56	0.22~1.1	0.28~1.8	0.56~3.1	0.83~5	1.11~6.1	1.39~10.6	1.39~16.7	2.8~20.8	8.3~27.8	11.1~33.3	16.6~41.6	22.2~50
Max pressure [bar]	28	25	24	27	16	26	28	28	29	38	34	25	23
Motor power [kW]	0.37~2.2	0.37~3	0.37~4	0.75~7.5	1.5~7.5	0.55~15	1.1~22	1.1~37	2.2~37	7.5~75	9.2~75	11~110	9.2~110
Max efficiency [%]	45	56	59	60	60	73	74	75	79	79	80	77	77
Pipe screw joint	Rp1 ¹ / ₄	Rp1 ¹ / ₄	Rp1 ¹ / ₂	Rp2	Rp2	Rp2 ¹ / ₂	Rp3	Rp3	Rp4	Rp5	Rp5	Rp6	Rp6

Rated flow [m³/h]	1	3	5	8	12	17	30	42	60	75	95	120	150
Rated flow [1/s]	0.28	0.83	1.39	2.22	3.33	4.72	8.33	11.7	16.7	20.8	26.4	33.3	41.6
Flow range [m³/h]	0.2~1.8	0.6~4.6	1.0~7.5	2~12	4~21	4~26	8~46	10~70	10~90	40~120	50~145	70~170	90~200
Flow range [1/s]	0.06~0.5	0.17~1.3	0.28~2.1	0.56~3.3	1.1~5.8	1.1~7.2	2.2~12.8	2.8~19.4	2.8~25	11.1~33.3	13.9~40.3	19.4~47.2	25~55.5
Max pressure [bar]	30	29	28	22	13	27	28	26	24	30	27	21	18
Motor power [kW]	0.37~3	0.37~4	0.55~5.5	0.75~7.5	1.5~7.5	1.1~15	1.5~22	3~37	3~37	13~75	15~75	15~110	15~110
Max efficiency [%]	45	58	59	60	61	74	75	75	79	79	80	77	77
Pipe screw joint	Rp1 ¹ / ₄	Rp1 ¹ / ₄	Rp1 ¹ / ₂	Rp2	Rp2	Rp2 ¹ / ₂	Rp3	Rp3	Rp4	Rp5	Rp5	Rp6	Rp6

● Typical applications

- Circulation or boosting for clean water, demineralized water.
- Water supply, irrigating system.
- Lowering ground water level.
- Boosting.
- Other industrial applications.

● Operation conditions

- Solid grain-or-fiber-free dilute clean non-corrosive liquids;
- Maximum liquid temperature: 35°C
- Maximum working pressure: 38 bar
- pH: 6.5~8.5
- Maximum diving depth: ≤50m

● NEMA Motor

- 4" Motor Stainless steel (there is bronze flange or ss flange)
- Single phase: 0.37kW~1.5kW
- Three phase: 0.37kW~7.5kW
- 6" Motor Cast iron (Standard), Stainless steel (If required, need to specify) Three phase: 4kW~37kW
- 8" Motor Cast iron (Standard), Stainless steel (If required, need to specify) Three phase: 5.5kW~110kW
- 10" Motor Stainless steel
- Three phase: 30kW~110kW

● Definition of Model

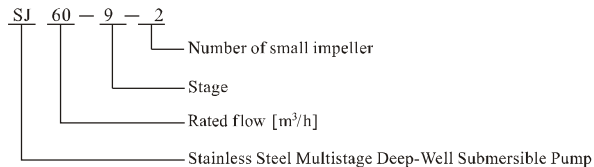
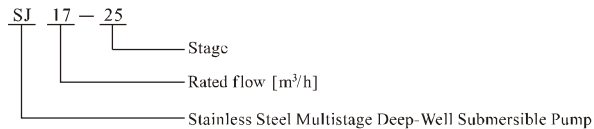

● Curve conditions

- The curve tolerance complies with ISO9906 Annex A.
- All curves are based on the measured values of 50Hz: constant motor speed 2850r/min or 2900r/min, 60Hz: constant motor speed 3440r/min or 3500r/min.
- All measurements are carried out with gas-free water of temperature 20°C. The curve is applicable to kinematical viscosity 1mm²/s. In case density of the liquid conveyed by the pump is higher than that of water, it is necessary to use corresponding motor of higher output power.
- The coarse part of the curve means the recommended performance scope.
- The performance curve includes loss caused by check valve etc.

● Performance curve

- Q/H curve means flow and head under the rated speed.
- Power curve: P2 means input power of each grade, Curves are shown for complete (1/1) and for reduced diameter (2/3) impellers.
- Efficiency curve: Eta means the stage efficiency of the pump

● Section drawing

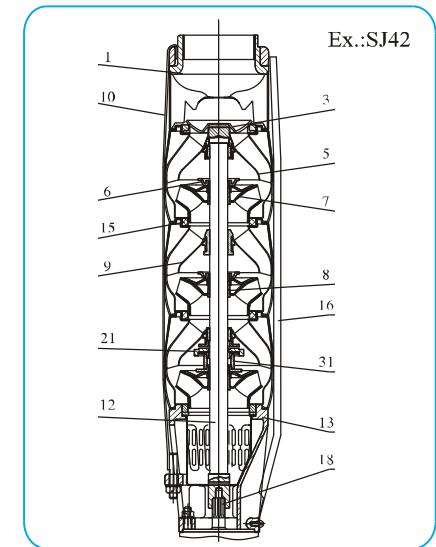
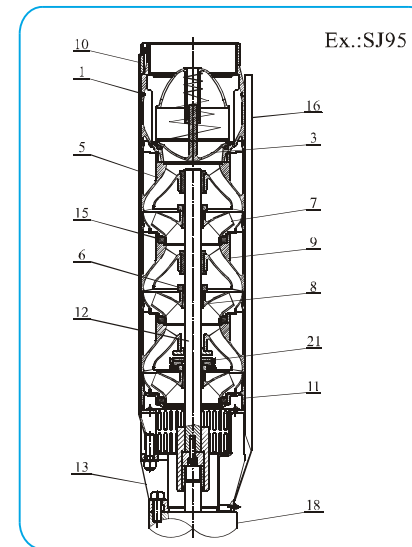
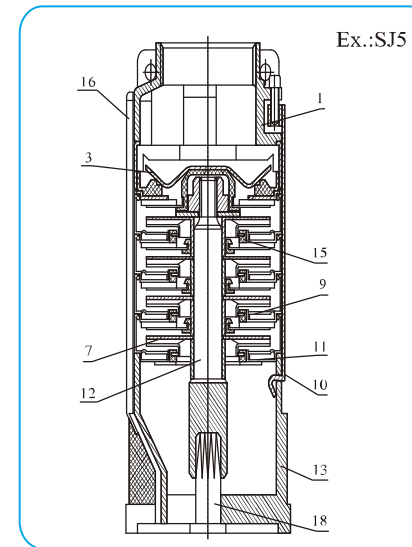

● Material

NO.	Name	Material	AISI
1	Discharge head	SS304	AISI304
3	Valve cap	SS304	AISI304
5	Discharge diffuser	SS304	AISI304
6	Impeller nut	SS304	AISI304
7	Impeller	SS304	AISI304
8	Impeller cone	SS304	AISI304
9	Diffuser	SS304	AISI304
10	Straps	SS304	AISI304
11	Inducer	SS304	AISI304
12	Pump shaft	SS304/420/431	AISI304/420/431
13	Suction Interconnector	SS304	AISI304
15	Neck ring	PBT/NBR	
16	Cable guard	SS304	AISI304
18	Submersible motor		
21	Inlet spacer	Carbon	
31	Connecting sleeve	SS304	AISI304

● Performance curve

ISO9906 Annex A 2850rpm

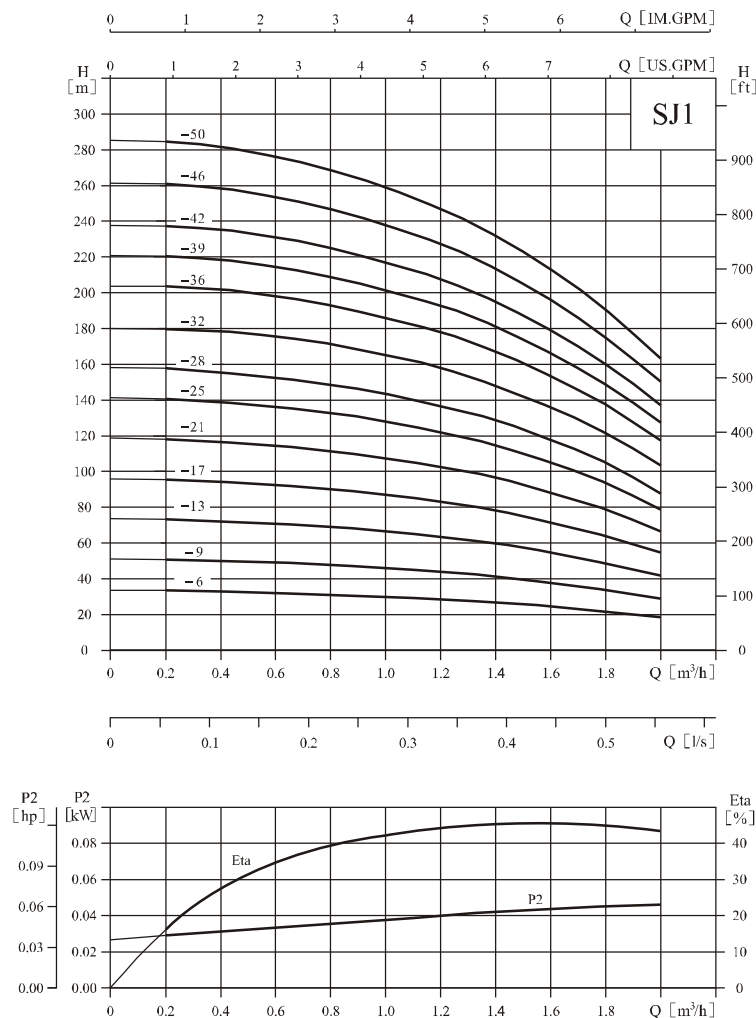

● Performance table

Model	Driving motor		Q (m³/h)	H (m)										
	(kW)	(hp)		0.2	0.4	0.6	0.8	1.0	1.2	1.4	1.6	1.8	2.0	
SJ1-6	0.37	0.5		33.5	33	32	31	30	29	27	25	22	19	
SJ1-9	0.37	0.5		51	50	49	48	46	44	41	38	34	29	
SJ1-13	0.55	0.75		73	72	71	69	67	64	60	55	49	42	
SJ1-17	0.75	1		96	95	92	90	87	84	78	71	64	55	
SJ1-21	1.1	1.5		119	118	115	112	108	103	97	89	80	69	
SJ1-25	1.1	1.5		141	140	137	134	129	123	116	106	95	82	
SJ1-28	1.5	2		158	157	153	150	145	138	130	119	107	92	
SJ1-32	1.5	2		180	179	175	171	165	158	148	136	122	105	
SJ1-36	1.5	2		203	202	197	192	186	178	167	153	137	118	
SJ1-39	2.2	3		221	219	214	209	202	193	181	166	149	128	
SJ1-42	2.2	3		238	236	230	225	217	208	195	179	160	137	
SJ1-46	2.2	3		260	258	252	246	238	227	213	196	176	151	
SJ1-50	2.2	3		284	282	276	269	260	248	233	214	192	165	

● Installation sketch

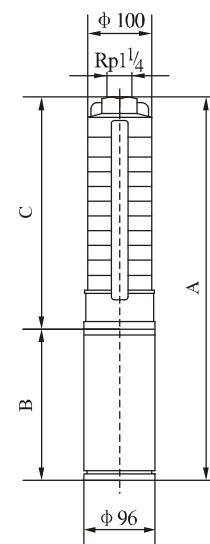

● Size and weight

Model	Size (mm)			Weight (kg)
	A	B	C	
SJ1-6	667	370	297	12
SJ1-9	730	370	360	13
SJ1-13	824	380	444	15
SJ1-17	928	400	528	17
SJ1-21	1052	440	612	19
SJ1-25	1136	440	696	20
SJ1-28	1229	470	759	23
SJ1-32	1313	470	843	24
SJ1-36	1397	470	927	25
SJ1-39	1500	510	990	29
SJ1-42	1563	510	1053	30
SJ1-46	1647	510	1137	31
SJ1-50	1731	510	1221	32

Note: The size B is varied with the motors of different manufacturers.

● Performance curve

ISO9906 Annex A 2850rpm

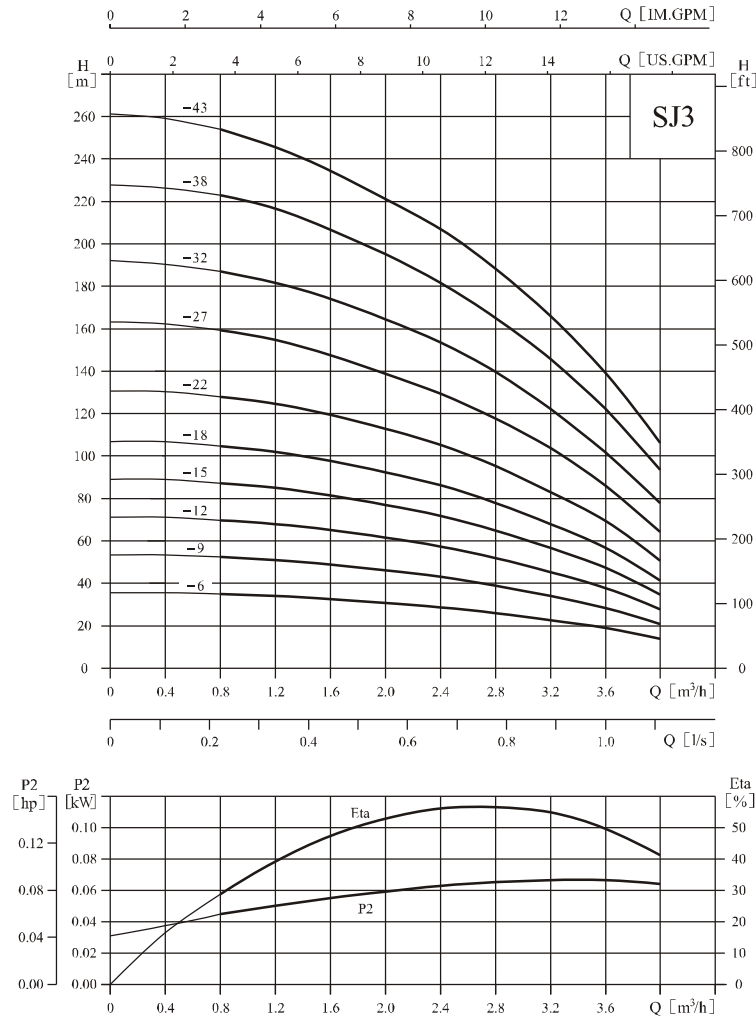

● Performance table

Model	Driving motor		Q (m³/h)	H (m)									
	(kW)	(hp)		0.8	1.2	1.6	2.0	2.4	2.8	3.0	3.2	3.6	4.0
SJ3-6	0.37	0.5		36	34	32	30	28	26	24	23	18	13
SJ3-9	0.55	0.75		53	51	48	45	42	38	36	33	27	20
SJ3-12	0.75	1		70	68	64	61	57	52	49	44	37	27
SJ3-15	1.1	1.5		87	85	81	77	72	65	61	56	47	34
SJ3-18	1.1	1.5		105	103	97	92	87	78	74	68	57	42
SJ3-22	1.5	2		130	126	120	113	106	96	91	84	70	53
SJ3-27	2.2	3		159	154	146	138	130	118	111	104	87	66
SJ3-32	2.2	3		189	183	173	163	154	140	131	122	102	79
SJ3-38	3.0	4		224	217	205	194	183	168	157	146	122	94
SJ3-43	3.0	4		254	246	233	220	207	190	178	166	139	107

● Installation sketch

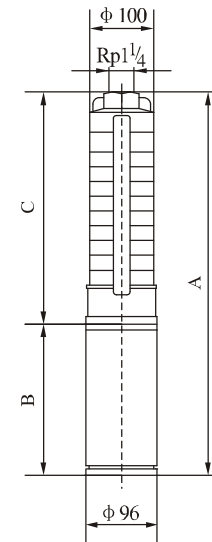

● Size and weight

Model	Size (mm)			Weight (kg)
	A	B	C	
SJ3-6	667	370	297	12
SJ3-9	740	380	360	13
SJ3-12	823	400	423	16
SJ3-15	926	440	486	18
SJ3-18	999	440	549	19
SJ3-22	1103	470	633	22
SJ3-27	1248	510	738	27
SJ3-32	1353	510	843	28
SJ3-38	1589	620	969	31
SJ3-43	1694	620	1074	32

Note: The size B is varied with the motors of different manufacturers.

● Performance curve

ISO9906 Annex A 2850rpm

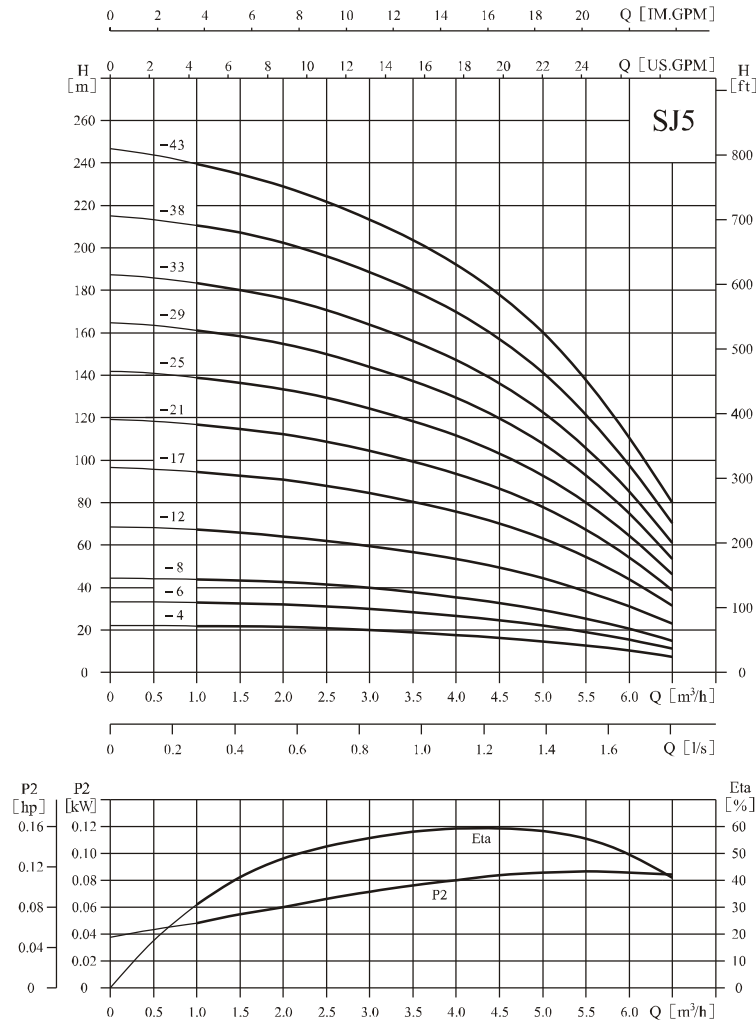

● Performance table

Model	Driving motor		Q (m³/h)	H (m)										
	(kW)	(hp)		1.0	2.0	3.0	3.5	4.0	4.5	5.0	5.5	6.0	6.5	
SJ5-4	0.37	0.5		21	20.5	20	19	18	17	15	13	10	8	
SJ5-6	0.55	0.75		32	31	30	28	27	25	22	19	15	11	
SJ5-8	0.75	1		43	42	40	38	36	33	30	25	20	15	
SJ5-12	1.1	1.5		66	63	59	57	54	50	45	38	30	23	
SJ5-17	1.5	2		95	91	84	80	76	71	64	54	43	32	
SJ5-21	2.2	3		117	112	104	99	94	87	79	67	53	39	
SJ5-25	2.2	3		139	134	124	118	112	104	94	80	64	47	
SJ5-29	3.0	4		161	155	144	137	130	120	108	92	74	55	
SJ5-33	3.0	4		183	177	163	156	148	137	123	105	84	62	
SJ5-38	4.0	5.5		211	203	188	178	170	158	142	121	97	71	
SJ5-43	4.0	5.5		239	230	213	203	193	179	161	137	109	81	

● Installation sketch

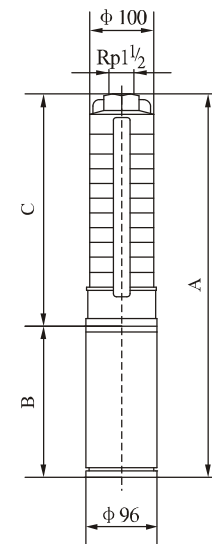

● Size and weight

Model	Size (mm)			Weight (kg)
	A	B	C	
SJ5-4	625	370	255	12
SJ5-6	677	380	297	13
SJ5-8	739	400	339	15
SJ5-12	863	440	423	17
SJ5-17	998	470	528	21
SJ5-21	1122	510	612	26
SJ5-25	1206	510	696	27
SJ5-29	1400	620	780	29
SJ5-33	1484	620	864	30
SJ5-38	1719	750	969	33
SJ5-43	1824	750	1074	35

Note: The size B is varied with the motors of different manufacturers.

● Performance curve

ISO9906 Annex A 2850rpm

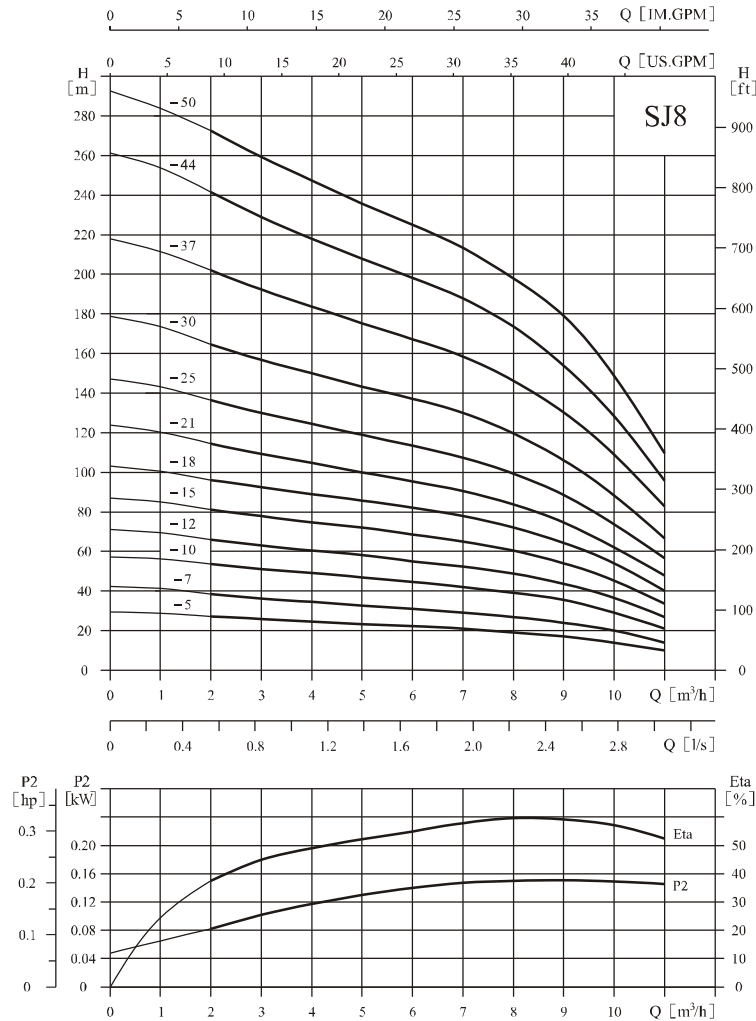

● Performance table

Model	Driving motor		Q (m³/h)	H (m)										
	(kW)	(hp)		2	3	4	5	6	7	8	9	10	11	
SJ8-5	0.75	1		27	26	24	23	22	21	19	17	14	10	
SJ8-7	1.1	1.5		38	36	34	33	31	29	27	24	20	14	
SJ8-10	1.5	2		54	52	50	47	45	42	39	35	29	21	
SJ8-12	2.2	3		65	62	60	57	54	51	47	42	35	26	
SJ8-15	2.2	3		81	77	74	71	68	64	59	53	44	33	
SJ8-18	3.0	4		95	93	89	86	81	77	71	63	53	40	
SJ8-21	4.0	5.5		112	108	104	100	95	90	83	74	62	47	
SJ8-25	4.0	5.5		135	129	124	119	113	108	99	89	74	56	
SJ8-30	5.5	7.5		162	155	149	143	136	130	119	106	88	67	
SJ8-37	5.5	7.5		201	191	184	176	167	159	147	131	109	82	
SJ8-44	7.5	10		242	227	218	209	199	190	174	156	129	98	
SJ8-50	7.5	10		272	258	248	238	226	216	198	177	147	111	

● Installation sketch

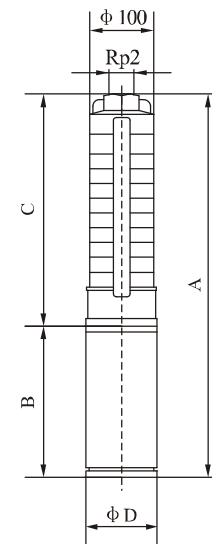

● Size and weight

Model	Size(mm)(Coupled to 4"/6" motor)				Weight (kg)
	A	B	C	phi D	
SJ8-5	853	400	453	96	16
SJ8-7	977	440	537	96	19
SJ8-10	1133	470	663	96	22
SJ8-12	1257	510	747	96	27
SJ8-15	1383	510	873	96	29
SJ8-18	1619	620	999	96	32
SJ8-21	1875	750	1125	96/143	35/41
SJ8-25	2043	750	1293	96/143	37/43
SJ8-30	2343	840	1503	96/143	43/51
SJ8-37	2637	840	1797	96/143	46/54
SJ8-44	3011	920	2091	96/143	55/66
SJ8-50	3263	920	2343	96/143	58/69

Note: The size B is varied with the motors of different manufacturers.

● Performance curve

ISO9906 Annex A 2850rpm

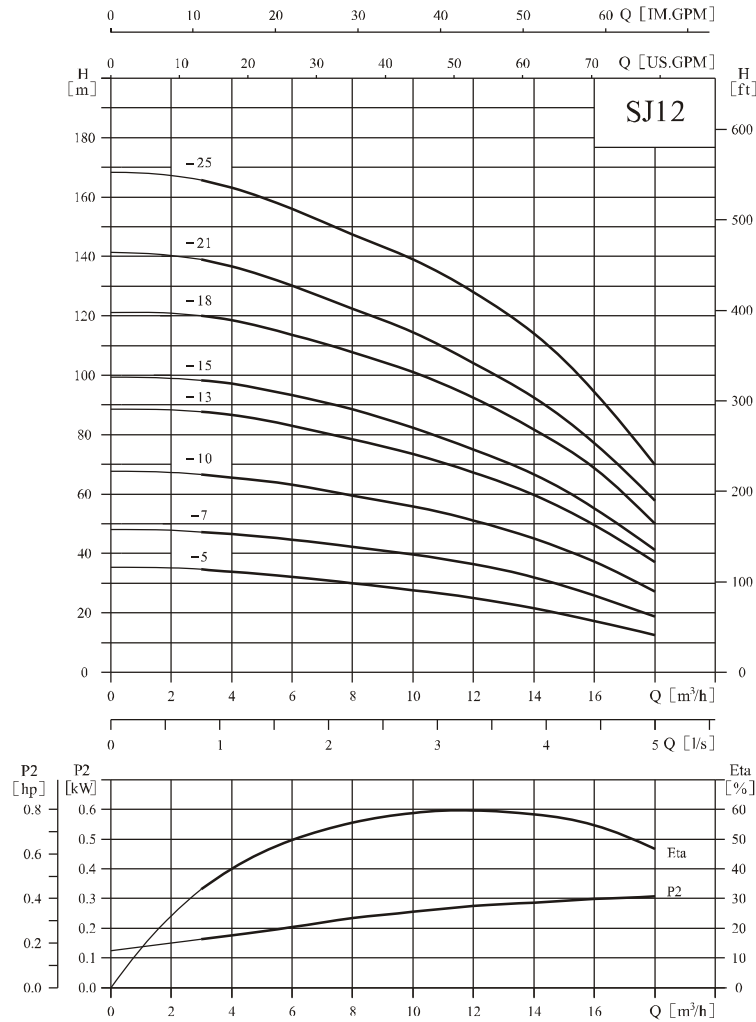

● Performance table

Model	Driving motor		Q (m³/h)	3	4	6	8	10	12	14	16	18
	(kW)	(hp)										
SJ12-5	1.5	2	H (m)	34	33	31	29	27	25	22	18	13
SJ12-7	2.2	3		48	46	43	40	38	35	31	25	19
SJ12-10	3.0	4		67	65	62	58	55	50	45	36	27
SJ12-13	4.0	5.5		88	86	81	76	71	66	59	48	36
SJ12-15	5.5	7.5		99	97	93	88	82	76	68	55	41
SJ12-18	5.5	7.5		120	118	112	105	99	91	81	66	50
SJ12-21	7.5	10		138	136	130	123	115	106	95	77	58
SJ12-25	7.5	10		166	163	155	146	137	126	113	92	69

● Installation sketch

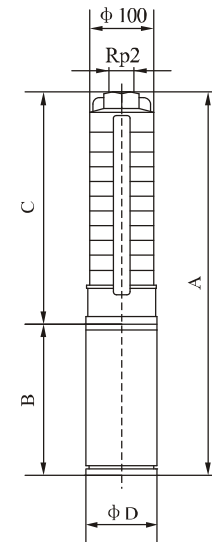

● Size and weight

Model	Size(mm)(Coupled to 4"/6" motor)				Weight (kg)
	A	B	C	phi D	
SJ12-5	1005	470	535	96	21
SJ12-7	1175	510	665	96	26
SJ12-10	1480	620	860	96	30
SJ12-13	1805	750	1055	96/143	34/40
SJ12-15	2025	840	1185	96/143	38/46
SJ12-18	2220	840	1380	96/143	40/48
SJ12-21	2495	920	1575	96/143	47/58
SJ12-25	2755	920	1835	96/143	50/61

Note: The size B is varied with the motors of different manufacturers.

● Performance curve

ISO9906 Annex A 2850rpm

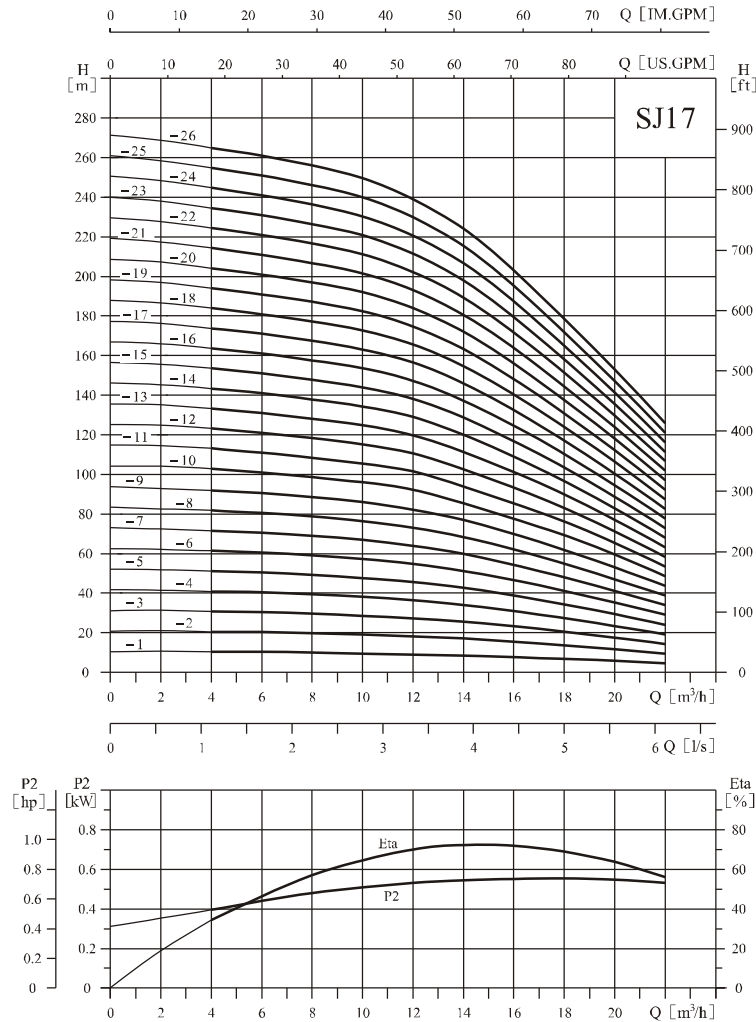

● Performance table

Model	Driving motor		Q (m³/h)	4	6	8	10	12	14	17	20	22
	(kW)	(hp)										
SJ17-1	0.55	0.75		10.5	10	9.5	9	8.5	8	6.5	5	4
SJ17-2	1.1	1.5		20.5	20	19.5	19	18	16	13.5	10.5	8
SJ17-3	2.2	3		31	30	29.5	28.5	27	24.5	20.5	16	13
SJ17-4	2.2	3		41	40	39.5	38	36.5	33.5	28	22	18
SJ17-5	3.0	4		52	51	50	48	45	42	35	28	23
SJ17-6	4.0	5.5		62	61	60	58	55	51	42	34	27
SJ17-7	4.0	5.5		73	71	70	67	64	59	49	40	31
SJ17-8	5.5	7.5		83	81	80	77	73	67	57	45	36
SJ17-9	5.5	7.5		93	91	90	87	82	76	64	52	40
SJ17-10	5.5	7.5		103	101	100	97	91	85	72	58	45
SJ17-11	7.5	10		113	111	109	106	100	94	79	64	50
SJ17-12	7.5	10		123	121	119	115	109	102	87	70	55
SJ17-13	7.5	10		133	131	129	125	118	111	95	75	60
SJ17-14	9.2	12.5		143	141	139	134	128	119	102	81	65
SJ17-15	9.2	12.5		153	151	148	144	137	128	109	87	70
SJ17-16	9.2	12.5		163	161	158	154	146	136	116	92	75
SJ17-17	9.2	12.5		173	171	167	163	155	145	123	98	79
SJ17-18	11	15		184	181	177	173	164	154	130	104	84
SJ17-19	11	15		194	191	187	182	174	162	138	110	89
SJ17-20	11	15		204	201	197	192	184	171	145	116	94
SJ17-21	13	17.5		214	211	207	202	193	180	152	121	99
SJ17-22	13	17.5		224	221	217	211	202	188	160	127	104
SJ17-23	13	17.5		235	231	227	221	211	197	167	133	109
SJ17-24	13	17.5		245	241	236	230	220	205	174	139	113
SJ17-25	15	20		255	251	246	240	229	213	181	145	118
SJ17-26	15	20		265	261	256	250	238	222	189	150	122

● Installation sketch

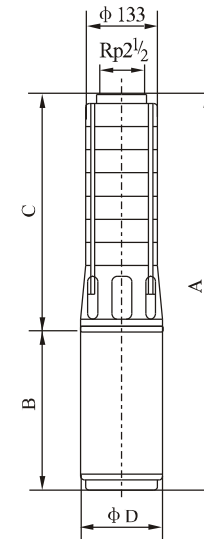

● Size and weight

Model	Size(mm)(Coupled to 4/6' motor)				Weight (kg)
	A	B	C	φ D	
SJ17-1	708	380	328	96	17
SJ17-2	828	440	388	96	21
SJ17-3	959	510	449	96	28
SJ17-4	1019	510	509	96	29
SJ17-5	1190	620	570	96	32
SJ17-6	1380	750	630	96/143	35/41
SJ17-7	1441	750	691	96/143	36/42
SJ17-8	1591	840	751	96/143	41/49
SJ17-9	1652	840	812	96/143	42/50
SJ17-10	1712	840	872	96/143	43/51
SJ17-11	1853	920	933	96/143	49/60
SJ17-12	1913	920	993	96/143	50/61
SJ17-13	1974	920	1054	96/143	51/62
SJ17-14	2000	870	1130	143	75
SJ17-15	2061	870	1191	143	76
SJ17-16	2121	870	1251	143	77
SJ17-17	2182	870	1312	143	78
SJ17-18	2292	920	1372	143	85
SJ17-19	2353	920	1433	143	86
SJ17-20	2413	920	1493	143	87
SJ17-21	2534	980	1554	143	95
SJ17-22	2594	980	1614	143	96
SJ17-23	2655	980	1675	143	98
SJ17-24	2715	980	1735	143	99
SJ17-25	2826	1030	1796	143	106
SJ17-26	2886	1030	1856	143	107

Note: The size B is varied with the motors of different manufacturers.

● Performance curve

ISO9906 Annex A 2850rpm

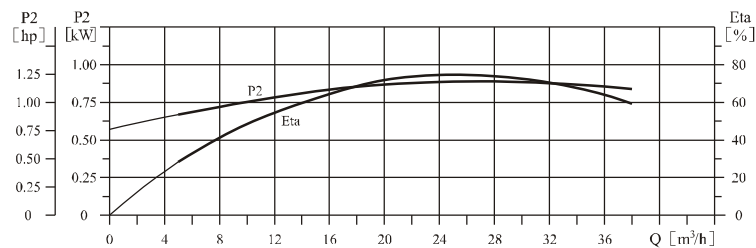
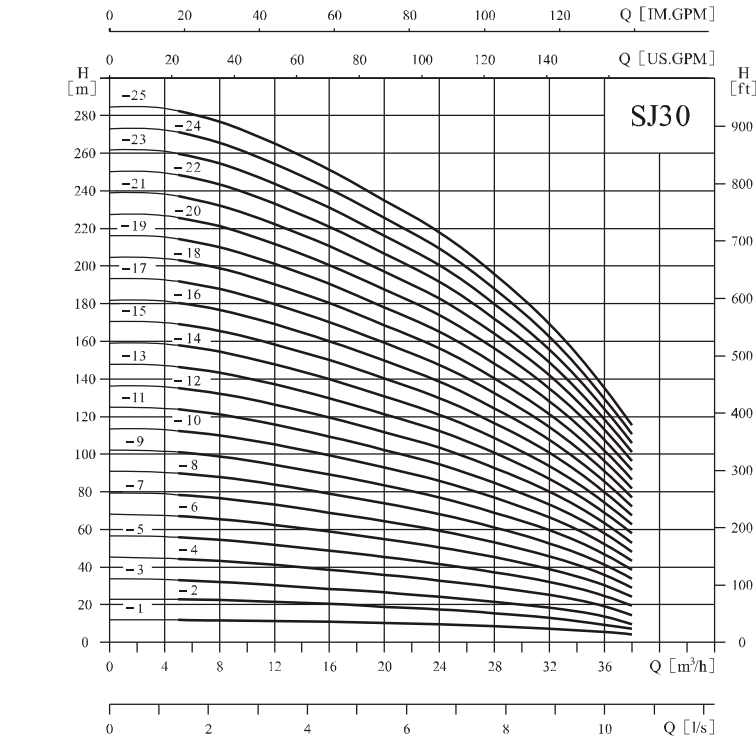

● Performance table

Model	Driving motor		Q (m ³ /h)	5	8	12	16	20	24	28	30	32	36	38
	(kW)	(hp)												
SJ30-1	1.1	1.5	11.5	11	10.5	10	9.5	9	8	7.5	7	5.5	4.5	
SJ30-2	2.2	3	22.5	22	21	20	19	17.5	16	15	14	10.5	9	
SJ30-3	3.0	4	33.5	33	32	30	28	26	24	22	20	16	14	
SJ30-4	4.0	5.5	44.5	44	42	40	37	35	32	29	27	21	18	
SJ30-5	5.5	7.5	55.5	55	53	50	47	44	40	37	34	27	23	
SJ30-6	5.5	7.5	67	66	63	60	56	52	48	44	41	32	27	
SJ30-7	7.5	10	77	76	74	70	65	61	55	52	48	37	32	
SJ30-8	7.5	10	89	87	84	80	75	70	63	59	54	43	36	
SJ30-9	9.2	12.5	101	98	95	90	84	78	71	66	61	48	41	
SJ30-10	9.2	12.5	112	109	105	100	93	87	79	74	68	53	45	
SJ30-11	9.2	12.5	123	120	116	110	103	96	87	81	75	59	50	
SJ30-12	11	15	134	131	126	120	112	105	95	88	82	64	54	
SJ30-13	11	15	145	142	137	129	121	113	103	96	88	69	59	
SJ30-14	13	17.5	157	153	147	139	130	122	111	103	95	74	63	
SJ30-15	13	17.5	168	164	158	149	140	131	119	110	102	80	68	
SJ30-16	15	20	180	175	168	159	149	140	127	118	109	85	72	
SJ30-17	15	20	190	186	179	169	158	148	135	125	116	90	77	
SJ30-18	18.5	25	201	197	189	179	168	157	143	132	122	96	81	
SJ30-19	18.5	25	212	207	200	189	177	166	150	140	129	101	86	
SJ30-20	18.5	25	223	218	210	199	186	174	158	147	136	106	90	
SJ30-21	18.5	25	235	229	221	209	196	183	166	155	143	112	95	
SJ30-22	22	30	246	240	231	219	205	192	174	162	150	117	99	
SJ30-23	22	30	258	251	242	229	214	201	182	169	156	122	104	
SJ30-24	22	30	269	262	252	239	224	209	190	177	163	128	108	
SJ30-25	22	30	281	273	263	249	233	218	198	184	170	133	113	

● Installation sketch

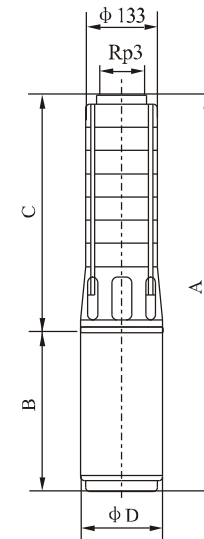

● Size and weight

Model	Size(mm)(Coupled to 4/6' motor)				Weight (kg)
	A	B	C	phi D	
SJ30-1	802	440	362	96	20
SJ30-2	968	510	458	96	28
SJ30-3	1174	620	554	96	31
SJ30-4	1400	750	650	96/143	35/41
SJ30-5	1586	840	746	96/143	40/48
SJ30-6	1682	840	842	96/143	42/50
SJ30-7	1858	920	938	96/143	49/60
SJ30-8	1954	920	1034	96/143	51/61
SJ30-9	2016	870	1146	143	75
SJ30-10	2112	870	1242	143	77
SJ30-11	2208	870	1338	143	79
SJ30-12	2354	920	1434	143	85
SJ30-13	2450	920	1530	143	87
SJ30-14	2606	980	1626	143	96
SJ30-15	2702	980	1722	143	98
SJ30-16	2848	1030	1818	143	106
SJ30-17	2944	1030	1914	143	108
SJ30-18	3100	1090	2010	143	117
SJ30-19	3196	1090	2106	143	119
SJ30-20	3292	1090	2202	143	120
SJ30-21	3388	1090	2298	143	122
SJ30-22	3554	1160	2394	143	138
SJ30-23	3650	1160	2490	143	140
SJ30-24	3746	1160	2586	143	142
SJ30-25	3842	1160	2682	143	144

Note: The size B is varied with the motors of different manufacturers.

● Performance curve

ISO9906 Annex A 2850rpm

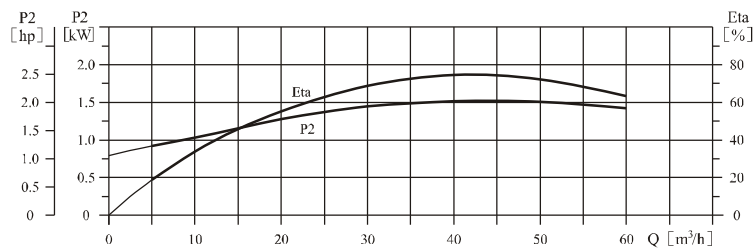
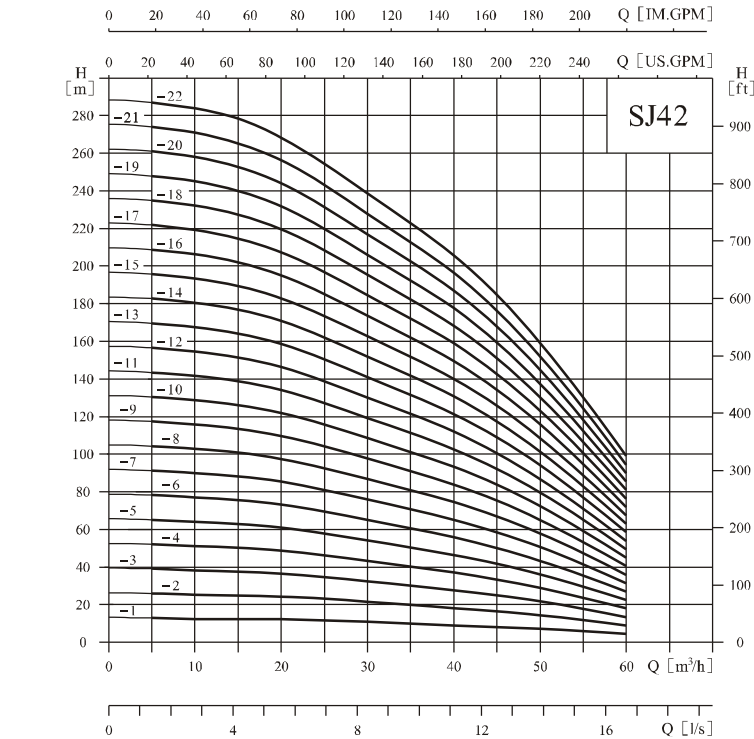

● Performance table

Model	Driving motor		Q (m³/h)	5	10	20	30	40	42	50	60
	(kW)	(hp)									
SJ42-1	2.2	3		13	12.5	12	10.5	9	8.5	7	4
SJ42-2	3.0	4		26	25.5	24	21.5	18.5	17	14.5	8.5
SJ42-3	5.5	7.5		40	38.5	36	32.5	28	26.5	22	13
SJ42-4	7.5	10		53	52	49	43	37	36	29	18
SJ42-5	7.5	10		66	65	61	54	47	45	38	23
SJ42-6	9.2	12.5		79	78	74	66	57	54	45	28
SJ42-7	11	15		92	91	86	77	66	63	52	32
SJ42-8	13	17.5		105	104	98	87	75	72	58	36
SJ42-9	15	20		118	117	110	97	84	80	65	40
SJ42-10	15	20		132	130	122	108	93	89	72	45
SJ42-11	18.5	25		144	142	134	119	103	98	79	49
SJ42-12	18.5	25		157	155	146	130	112	107	87	54
SJ42-13	22	30		170	168	158	141	122	116	94	58
SJ42-14	22	30		183	181	170	152	131	125	102	63
SJ42-15	22	30		196	194	182	163	140	134	109	67
SJ42-16	25	34		209	207	194	174	150	143	116	72
SJ42-17	25	34		222	220	206	184	159	152	123	77
SJ42-18	30	40		235	233	218	195	168	161	131	81
SJ42-19	30	40		248	246	231	206	178	170	138	86
SJ42-20	30	40		261	259	243	217	187	179	145	90
SJ42-21	37	50		274	271	255	228	196	188	152	95
SJ42-22	37	50		287	283	267	238	205	197	160	99

● Installation sketch

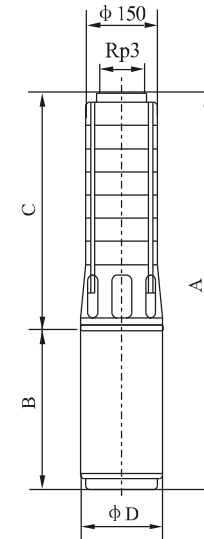

● Size and weight

Model	Size(mm)(Coupled to 4/6' motor)				Weight (kg)
	A	B	C	φ D	
SJ42-1	888	510	378	96	29
SJ42-2	1111	620	491	96	33
SJ42-3	1444	840	604	96/143	40/48
SJ42-4	1637	920	717	96/143	47/58
SJ42-5	1750	920	830	96/143	49/60
SJ42-6	1829	870	959	143	73
SJ42-7	1992	920	1072	143	80
SJ42-8	2165	980	1185	143	89
SJ42-9	2328	1030	1298	143	97
SJ42-10	2441	1030	1411	143	100
SJ42-11	2614	1090	1524	143	109
SJ42-12	2727	1090	1637	143	111
SJ42-13	2910	1160	1750	143	127
SJ42-14	3023	1160	1863	143	129
SJ42-15	3136	1160	1976	143	131
SJ42-16	3319	1230	2089	143	145
SJ42-17	3432	1230	2202	143	147
SJ42-18	3645	1330	2315	143	162
SJ42-19	3758	1330	2428	143	164
SJ42-20	3871	1330	2541	143	167
SJ42-21	4224	1570	2654	143	192
SJ42-22	4337	1570	2767	143	194

Note: The size B is varied with the motors of different manufacturers.

● Performance curve

ISO9906 Annex A 2850rpm

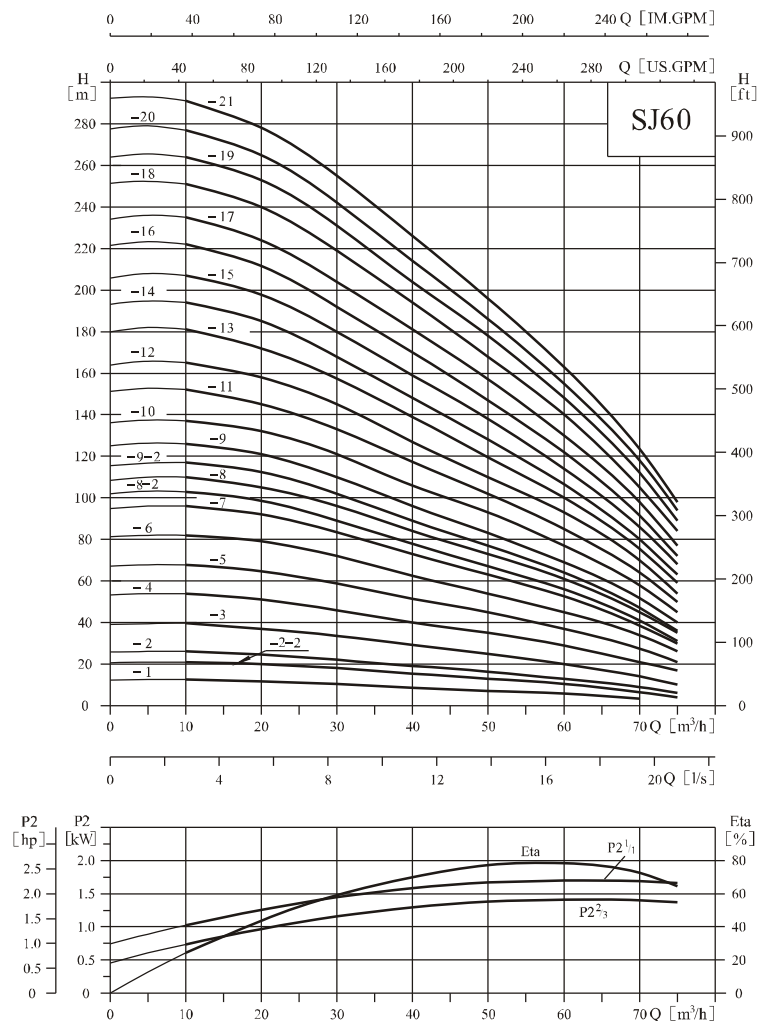

● Performance table

Model	Driving motor		Q (m³/h)	H (m)								
	(kW)	(hp)		10	20	30	40	50	60	70	75	
SJ60-1	2.2	3	12.5	12	10.5	8.5	7	6	4	-		
SJ60-2-2	3.0	4	21	20	18	15.5	13	10.5	6.5	4		
SJ60-2	4.0	5.5	26	24.5	22	19	16.5	12.5	9	6		
SJ60-3	5.5	7.5	40	37	34	29	25	20	14	10		
SJ60-4	7.5	10	54	51	46	40	35	29	21	17		
SJ60-5	9.2	12.5	68	65	59	51	45	37	28	21		
SJ60-6	11	15	82	79	72	62	54	45	34	26		
SJ60-7	13	17.5	96	92	84	73	63	53	39	30		
SJ60-8-2	13	17.5	103	99	89	78	67	56	41	31		
SJ60-8	15	20	110	105	96	84	73	61	45	35		
SJ60-9-2	15	20	117	112	102	89	77	64	47	36		
SJ60-9	18.5	25	124	121	110	96	85	69	52	40		
SJ60-10	18.5	25	137	132	121	106	93	77	58	45		
SJ60-11	22	30	152	145	133	117	102	85	64	50		
SJ60-12	22	30	165	158	145	127	110	93	70	54		
SJ60-13	22	30	181	172	157	139	120	100	75	59		
SJ60-14	25	34	194	185	168	148	128	106	80	63		
SJ60-15	25	34	207	198	180	159	138	114	85	68		
SJ60-16	30	40	222	212	192	170	147	122	91	72		
SJ60-17	30	40	235	224	204	181	157	130	98	77		
SJ60-18	30	40	251	240	219	194	168	140	105	84		
SJ60-19	37	50	264	253	231	204	178	148	112	89		
SJ60-20	37	50	277	265	242	214	186	155	118	94		
SJ60-21	37	50	291	278	255	226	196	163	123	98		

● Installation sketch

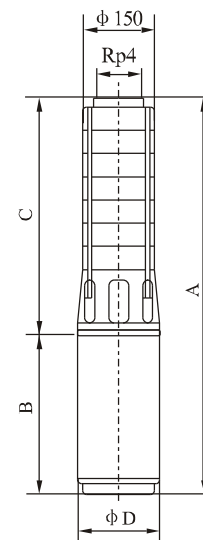

● Size and weight

Model	Size(mm)(Coupled to 4/6' motor)				Weight (kg)
	A	B	C	ϕD	
SJ60-1	878	510	368	96	30
SJ60-2-2	1101	620	481	96	33
SJ60-2	1231	750	481	96/143	35/41
SJ60-3	1434	840	594	96/143	41/49
SJ60-4	1627	920	707	96/143	48/59
SJ60-5	1690	870	820	143	72
SJ60-6	1869	920	949	143	78
SJ60-7	2042	980	1062	143	87
SJ60-8-2	2155	980	1175	143	88
SJ60-8	2205	1030	1175	143	96
SJ60-9-2	2318	1030	1288	143	97
SJ60-9	2378	1090	1288	143	105
SJ60-10	2491	1090	1401	143	107
SJ60-11	2674	1160	1514	143	123
SJ60-12	2787	1160	1627	143	125
SJ60-13	2900	1160	1740	143	127
SJ60-14	3083	1230	1853	143	141
SJ60-15	3196	1230	1966	143	143
SJ60-16	3409	1330	2079	143	158
SJ60-17	3522	1330	2192	143	160
SJ60-18	3635	1330	2305	143	162
SJ60-19	3988	1570	2418	143	188
SJ60-20	4101	1570	2531	143	190
SJ60-21	4214	1570	2644	143	191

Note: The size B is varied with the motors of different manufacturers.

● Performance curve

ISO9906 Annex A 2900rpm

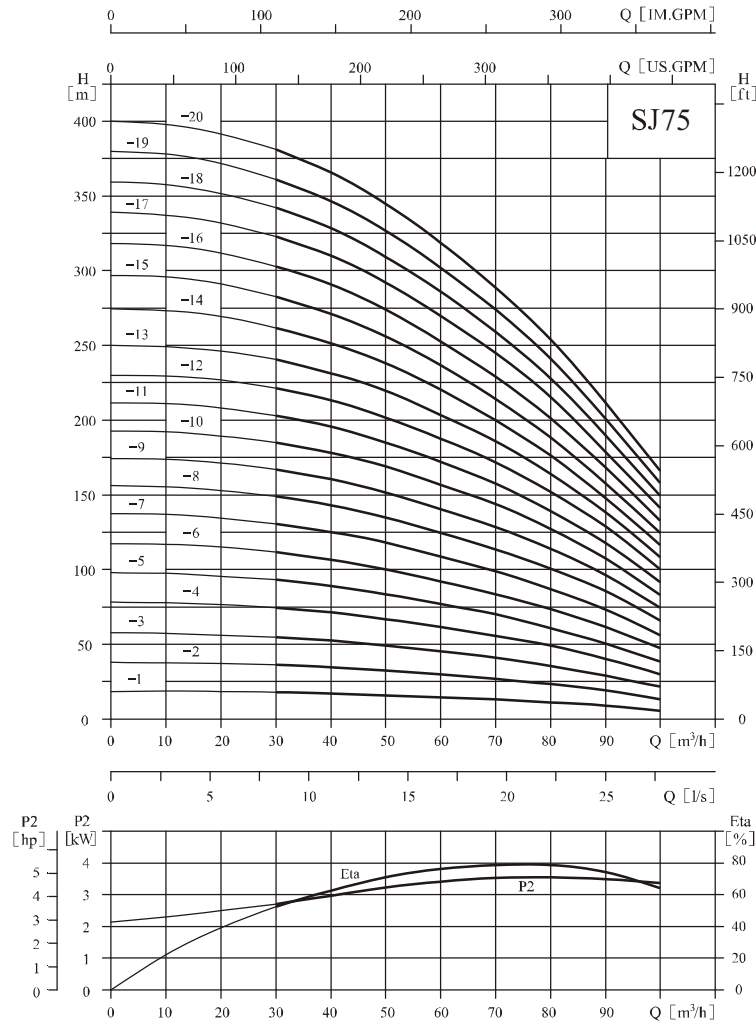

● Performance table

Model	Driving motor		Q (m³/h)	30	40	50	60	70	75	80	90	100
	(kW)	(hp)										
SJ75-1	4	5.5	18	17	15.5	14.5	13	12	11	9	5.5	
SJ75-2	7.5	10	36.5	34.5	32	30	27	25	23	19	12.5	
SJ75-3	11	15	54.5	52.5	49	45	41	38	35.5	29	21.5	
SJ75-4	15	20	73.5	71	66.5	61	55.5	52	48	40	30	
SJ75-5	18.5	25	92	89	83	76	70	65	60.5	51	38	
SJ75-6	22	30	111	107	100	91	84	79	73	62	47	
SJ75-7	30	40	130	125	118	107	98	93	87	73	56	
SJ75-8	30	40	148	143	135	124	113	107	101	85	65	
SJ75-9	37	50	167	161	152	140	128	121	114	96	74	
SJ75-10	37	50	185	178	169	157	143	135	127	107	83	
SJ75-11	45	60	203	196	185	172	158	148	139	118	92	
SJ75-12	45	60	222	214	202	188	172	162	152	129	100	
SJ75-13	55	75	241	232	220	204	186	175	164	139	108	
SJ75-14	55	75	262	251	238	220	200	188	176	149	116	
SJ75-15	55	75	283	271	256	236	214	201	188	159	124	
SJ75-16	63	85	303	291	274	253	229	215	202	169	133	
SJ75-17	63	85	323	310	292	270	245	229	215	179	142	
SJ75-18	75	100	342	329	309	286	259	243	228	190	150	
SJ75-19	75	100	361	347	327	302	274	257	241	201	158	
SJ75-20	75	100	381	366	345	318	288	271	254	212	167	

● Installation sketch

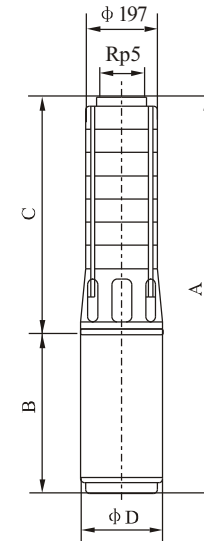

● Size and weight

Model	Size(mm)(Coupled to 6/8" motor)				Weight (kg)
	A	B	C	φ D	
SJ75-1	1268	780	488	143	56
SJ75-2	1424/1411	810/780	614/631	143/184	78/97
SJ75-3	1660/1577	920/820	740/757	143/184	92/116
SJ75-4	1896/1743	1030/860	866/883	143/184	110/134
SJ75-5	2082/1899	1090/890	992/1009	143/184	122/152
SJ75-6	2278/2075	1160/940	1118/1135	143/184	141/178
SJ75-7	2574/2311	1330/1050	1244/1261	143/184	171/211
SJ75-8	2700/2437	1330/1050	1370/1387	143/184	176/216
SJ75-9	3066/2663	1570/1150	1496/1513	143/184	204/233
SJ75-10	3192/2789	1570/1150	1622/1639	143/184	209/238
SJ75-11	3005	1240	1765	184	256
SJ75-12	3131	1240	1891	184	261
SJ75-13	3387	1370	2017	184	279
SJ75-14	3513	1370	2143	184	285
SJ75-15	3639	1370	2269	184	290
SJ75-16	3885	1490	2395	192	309
SJ75-17	4011	1490	2521	192	315
SJ75-18	4187	1540	2647	192	341
SJ75-19	4313	1540	2773	192	346
SJ75-20	4439	1540	2899	192	351

Note: The size B is varied with the motors of different manufacturers.

● Performance curve

ISO9906 Annex A 2900rpm

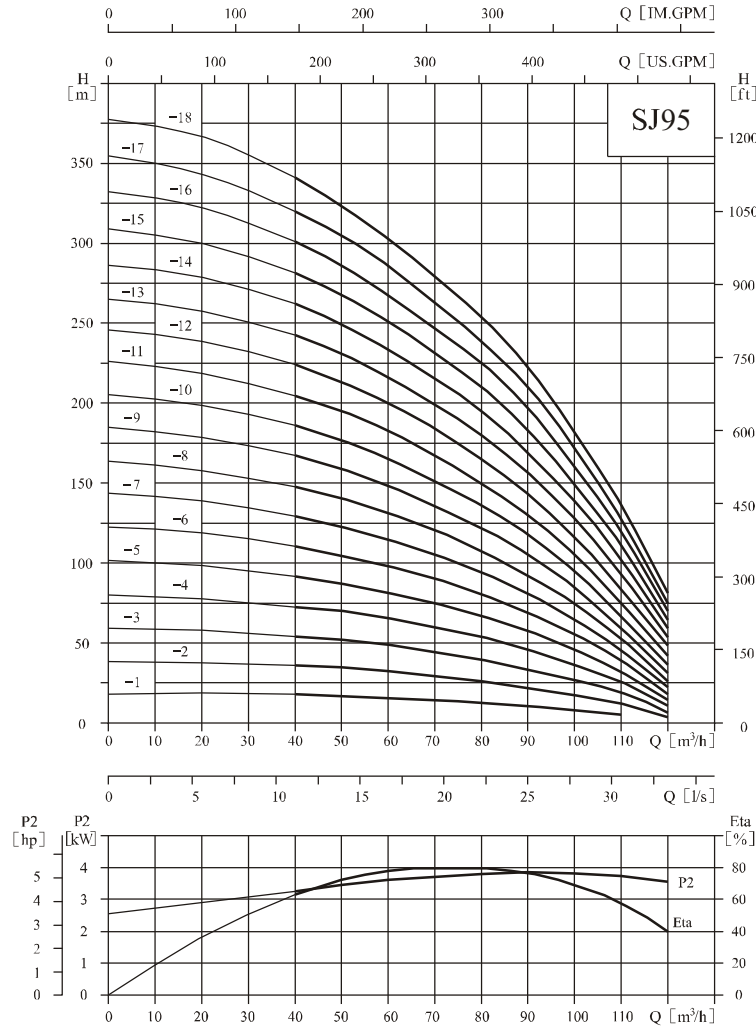

● Performance table

Model	Driving motor		Q (m ³ /h)	40	50	60	70	80	90	95	100	110	120
	(kW)	(hp)		H (m)									
SJ95-1	4	5.5	17.5	16.5	15.5	14	12.5	10.5	9.5	8	5	—	—
SJ95-2	9.2	12.5	36	34	32	28.5	26	21.5	20	17	12	12	3.5
SJ95-3	13	17.5	54	52	48.5	44.5	40	33	30	26	19	6	6
SJ95-4	18.5	25	72	70	65	60	54	45	41	36	25.5	10.5	10.5
SJ95-5	22	30	91	87	81.5	75	68	57	51.5	46	32	14.5	14.5
SJ95-6	25	34	110	104	98	90	81	69	62	55	38	18	18
SJ95-7	30	40	129	122	115	105	94	81	73	65	45	22	22
SJ95-8	37	50	148	141	131	120	108	93	84	75	52	26	26
SJ95-9	37	50	167	159	148	135	122	105	95	85	59	31	31
SJ95-10	45	60	186	177	165	151	136	117	106	95	67	36	36
SJ95-11	45	60	205	195	182	167	150	130	117	105	75	42	42
SJ95-12	55	75	224	213	199	183	165	143	129	116	84	48	48
SJ95-13	55	75	243	231	216	199	180	156	141	127	93	53	53
SJ95-14	55	75	262	249	233	215	195	169	153	138	102	59	59
SJ95-15	63	85	281	268	250	231	210	183	166	149	111	64	64
SJ95-16	63	85	301	286	267	247	225	197	178	160	119	70	70
SJ95-17	75	100	321	304	284	263	240	210	190	171	127	75	75
SJ95-18	75	100	342	323	302	279	255	222	202	182	135	81	81

● Installation sketch

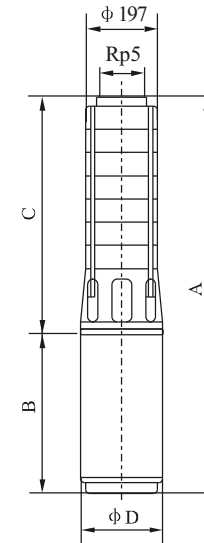

● Size and weight

Model	Size(mm)(Coupled to 6/8' motor)				Weight (kg)
	A	B	C	φ D	
SJ95-1	1268	780	488	143	57
SJ95-2	1484/1431	870/800	614/631	143/184	83/105
SJ95-3	1720/1617	980/860	740/757	143/184	100/129
SJ95-4	1956/1773	1090/890	866/883	143/184	119/148
SJ95-5	2152/1949	1160/940	992/1009	143/184	138/175
SJ95-6	2348/2125	1230/990	1118/1135	143/184	155/188
SJ95-7	2574/2311	1330/1050	1244/1261	143/184	174/213
SJ95-8	2940/2537	1570/1150	1370/1387	143/184	202/231
SJ95-9	3066/2663	1570/1150	1496/1513	143/184	208/237
SJ95-10	2879	1240	1639	184	254
SJ95-11	3005	1240	1765	184	260
SJ95-12	3261	1370	1891	184	279
SJ95-13	3387	1370	2017	184	284
SJ95-14	3513	1370	2143	184	290
SJ95-15	3759	1490	2269	192	310
SJ95-16	3885	1490	2395	192	316
SJ95-17	4061	1540	2521	192	342
SJ95-18	4187	1540	2647	192	348

Note: The size B is varied with the motors of different manufacturers.

● Performance curve

ISO9906 Annex A 2900rpm

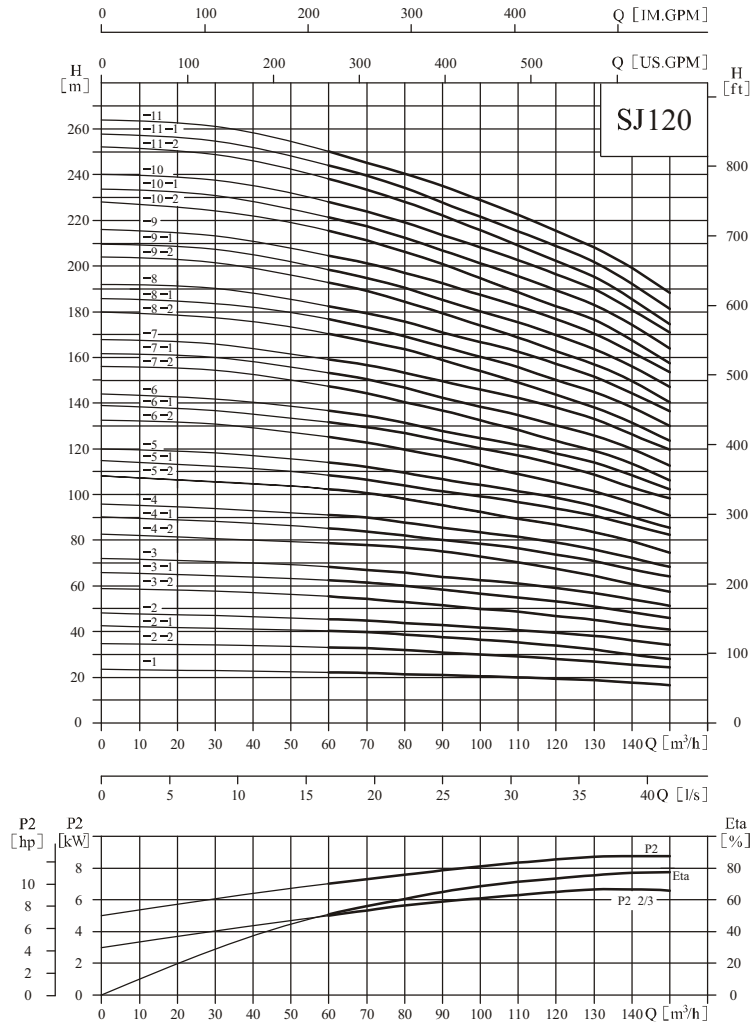

● Performance table

Model	Driving motor		Q (m³/h)	60	70	80	90	100	110	120	130	140	150	Model	Driving motor		Q (m³/h)	60	70	80	90	100	110	120	130	140	150
	(kW)	(hp)													(kW)	(hp)											
SJ120-1	11	15	22.5	22	21.5	21	20.5	20	19	18.5	17.5	16.5		SJ120-7	63	85	147	144	140.5	136.5	132.5	128	123	119	113	106	
SJ120-2	15	20	33.5	33	32	30	29	28.5	27.5	26.5	24.5	24		SJ120-7-1	63	85	153	150	146.5	142.5	138.5	135	130	125.5	120	112.5	
SJ120-2-1	18.5	25	40.5	40	38.5	37.5	36	35.5	33.5	32.5	29.5	28		SJ120-7	75	100	159	156.5	153	149	145	142	138	133	126	119.5	
SJ120-2	22	30	45.5	44.5	43.5	42.5	41.5	40.5	39	38	36	34		SJ120-8-2	75	100	170.5	167	164.5	158	153	148.5	143	138	131.5	123	
SJ120-3-2	25	34	55	54.5	52.5	51	49.5	48.5	46.5	45	42.5	40.5		SJ120-8-1	75	100	175.5	173	168.5	163.5	159	155.5	150	145	138	129.5	
SJ120-3-1	30	40	62.5	61.5	60	58	56	54	53.5	51	48.5	46		SJ120-8	75	100	181.5	179.5	175	170.5	166	163	157.5	152.5	144	136.5	
SJ120-3	30	40	68	67	65.5	64	62	61	59	57	54	51		SJ120-9-2	90	120	192.5	189	184	179.5	174	168.5	162.5	157	149.5	140	
SJ120-4-2	37	50	78.5	77	75	72.5	70.5	69	66.5	65	60.5	57.5		SJ120-9-1	90	120	198	195	190.5	185	180	175.5	169.5	164	156	147	
SJ120-4-1	37	50	85	84	82	79.5	77	76	73.5	71	67	64		SJ120-9	90	120	204	201.5	198	191.5	186.5	182.5	177.5	171.5	162	153.5	
SJ120-4	37	50	90.5	89.5	87.5	85.5	83	81.5	78.5	76	72	68		SJ120-10-2	90	120	215.5	211	206	200.5	194.5	188.5	182.5	176.5	167.5	157.5	
SJ120-5-2	45	60	102	100.5	97.5	95	91.5	90	86.5	84	79	74.5		SJ120-10-1	90	120	221	217	212	206.5	200.5	195.5	189.5	183	174	164	
SJ120-5-1	45	60	108.5	106.5	103.5	101	98.5	96.5	94	91	86.5	82		SJ120-10	110	150	227	223.5	219	213	207.5	202.5	197	190.5	180	170.5	
SJ120-5	55	75	113.5	112	109.5	106.5	103.5	101.5	98.5	95	90	85		SJ120-11-2	110	150	238	233	228	222	215.5	208	202	195.5	185.5	174.5	
SJ120-6-2	55	75	125	122.5	119	116.5	112.5	109	104.5	101.5	96	90.5		SJ120-11-1	110	150	243.5	239.5	234	227.5	221.5	215	209	202	192	181	
SJ120-6-1	55	75	131	129.5	126.5	123.5	120	117	113	109	103	98		SJ120-11	110	150	250	245.5	241	234.5	228	222.5	216.5	209.5	198.5	187.5	
SJ120-6	63	85	136	134.5	131	127.5	124.5	121.5	118	114	108	102															

● Installation sketch

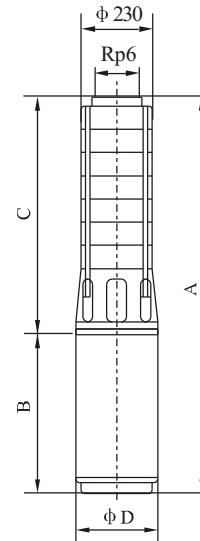

● Size and weight

Model	Size(mm)(Coupled to 6/8/10' motor)				(kg)
	A	B	C	φ D	
SJ120-1	1451/1380--	920/820--	531/560--	144/184--	96/121--
SJ120-2-2	1721/1580--	1030/860--	691/720--	144/184--	111/135--
SJ120-2-1	1781/1610--	1090/890--	691/720--	144/184--	118/140--
SJ120-2	1921/1660--	1230/940--	691/720--	144/184--	127/155--
SJ120-3-2	2081/1870--	1230/990--	851/880--	144/184--	142/173--
SJ120-3-1	2181/1930/2002	1330/1050/1122	851/880/880	144/184/236	148/187/227
SJ120-3	2181/1930/2002	1330/1050/1122	851/880/880	144/184/236	148/187/227
SJ120-4-2	2581/2190/2202	1570/1150/1162	1011/1040/1040	144/184/236	166/210/252
SJ120-4-1	2581/2190/2202	1570/1150/1162	1011/1040/1040	144/184/236	166/210/252
SJ120-4	2581/2190/2202	1570/1150/1162	1011/1040/1040	144/184/236	166/210/252
SJ120-5-2	--/2440/2392	--/1240/1192	--/1200/1200	--/184/236	--/233/282
SJ120-5-1	--/2440/2392	--/1240/1192	--/1200/1200	--/184/236	--/233/282
SJ120-5	--/2570/2472	--/1370/1272	--/1200/1200	--/184/236	--/253/315
SJ120-6-2	--/2730/2632	--/1370/1272	--/1360/1360	--/184/236	--/261/323
SJ120-6-1	--/2730/2632	--/1370/1272	--/1360/1360	--/184/236	--/261/323
SJ120-6	--/2850/2692	--/1490/1332	--/1360/1360	--/192/236	--/288/341
SJ120-7-2	--/3010/2852	--/1490/1332	--/1520/1520	--/192/236	--/296/349
SJ120-7-1	--/3010/2852	--/1490/1332	--/1520/1520	--/192/236	--/296/349
SJ120-7	--/3060/2942	--/1540/1422	--/1520/1520	--/192/236	--/306/387
SJ120-8-2	--/3220/3102	--/1540/1422	--/1680/1680	--/192/236	--/314/395
SJ120-8-1	--/3220/3102	--/1540/1422	--/1680/1680	--/192/236	--/314/395
SJ120-8	--/3220/3102	--/1540/1422	--/1680/1680	--/192/236	--/314/395
SJ120-9-2	--/3484/3371	--/1644/1531	--/1840/1840	--/192/236	--/342/416
SJ120-9-1	--/3484/3371	--/1644/1531	--/1840/1840	--/192/236	--/342/416
SJ120-9	--/3484/3371	--/1644/1531	--/1840/1840	--/192/236	--/342/416
SJ120-10-2	--/3644/3531	--/1644/1531	--/2000/2000	--/192/236	--/350/424
SJ120-10-1	--/3644/3531	--/1644/1531	--/2000/2000	--/192/236	--/350/424
SJ120-10	--/3764/3641	--/1764/1641	--/2000/2000	--/192/236	--/376/461
SJ120-11-2	--/3924/3801	--/1764/1641	--/2160/2160	--/192/236	--/384/469
SJ120-11-1	--/3924/3801	--/1764/1641	--/2160/2160	--/192/236	--/384/469
SJ120-11	--/3924/3801	--/1764/1641	--/2160/2160	--/192/236	--/384/469

Note: The size B is varied with the motors of different manufacturers.

● Performance curve ISO9906 Annex A 2900rpm

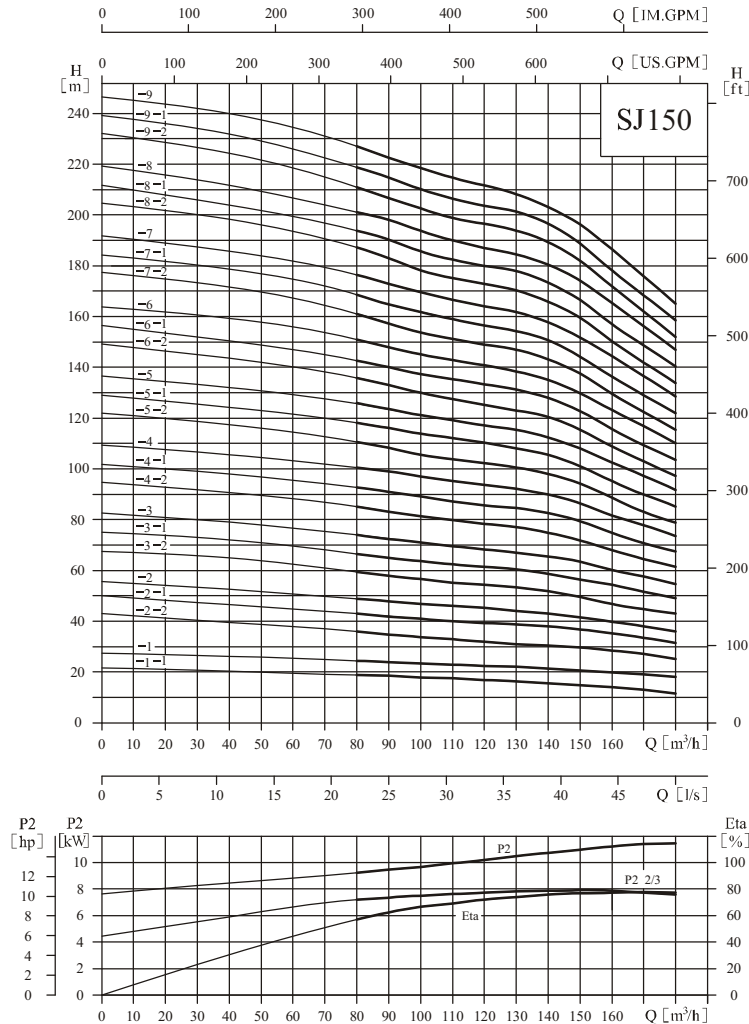

● Performance table

Model	Driving motor		Q (m³/h)	H (m)										
	(kW)	(hp)		80	90	100	110	120	130	140	150	160	170	180
SJ150-1-1	9.2	12.5	18.5	18	17.5	17	16.5	16	15	14.5	13.5	13	11.5	
SJ150-1	13	17.5	24	23.5	23	22.5	22	21.5	21	20	19.5	19	18	
SJ150-2-2	18.5	25	35.5	34	32	31.5	31	29.5	29	28.5	28	27	25	
SJ150-2-1	22	30	43	41.5	40	39	38.5	38	37.5	36	35.5	34	31	
SJ150-2	25	34	48.5	47.5	46	45	44.5	44	42.5	41	39.5	38	36	
SJ150-3-2	30	40	60	57	54.5	54	53.5	53	52.5	49.5	46.5	44.5	43	
SJ150-3-1	37	50	66.5	64	62.5	61.5	60.5	60	59.5	56.5	54	51.5	49	
SJ150-3	37	50	74.5	72.5	70.5	69.5	68	67.5	65.5	63.5	60	57.5	54.5	
SJ150-4-2	45	60	85.5	83	80	79	77.5	77	76	73	66.5	63.5	61	
SJ150-4-1	45	60	93	90	87.5	86.5	84.5	83.5	83	79.5	73.5	70.5	67	
SJ150-4	55	75	100.5	98	96	94.5	93	92.5	89.5	86.5	80.5	77.5	73	
SJ150-5-2	55	75	111.5	107	104	103	102	101	98	94	86.5	81.5	78.5	
SJ150-5-1	55	75	118.5	114.5	112	110.5	108.5	107	105.5	101	94	89.5	85	
SJ150-5	63	85	126	122.5	120	118	116	115	112.5	108.5	101.5	97	91.5	
SJ150-6-2	63	85	137	131.5	128	126.5	123	122	120.5	115.5	107	101	97	
SJ150-6-1	75	100	144	139	136	134	132	131.5	128	122.5	114.5	109	103.5	
SJ150-6	75	100	151.5	147	144	141.5	139.5	138	135	130	122	116.5	110	
SJ150-7-2	75	100	162.5	156	152.5	150.5	146	145	143	138	128	121	115	
SJ150-7-1	90	120	169.5	163.5	160.5	158	155	153	150.5	145	135.5	129	121.5	
SJ150-7	90	120	177	171.5	168.5	165.5	163.5	162.5	157.5	152.5	143	136.5	128	
SJ150-8-2	90	120	188	180.5	177	174.5	172	171	165.5	160.5	149	140.5	133.5	
SJ150-8-1	110	150	195	188	185	182	180	178.5	173	168.5	156.5	148.5	140	
SJ150-8	110	150	202.5	196	193	189.5	187	186	180	175	164	156	146.5	
SJ150-9-2	110	150	213.5	205	201.5	198	196	194	188.5	182.5	170.5	160	152	
SJ150-9-1	110	150	220.5	212.5	209.5	205.5	203	201.5	196	189.5	178	168	158.5	
SJ150-9	110	150	228	220.5	217.5	213	210	209	203	197	185.5	175.5	165	

● Installation sketch

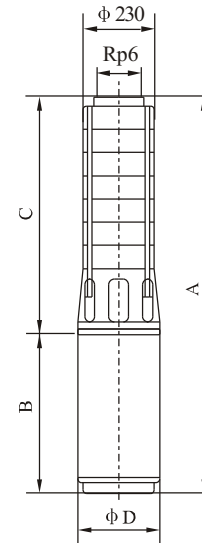

● Size and weight

Model	Size(mm)(Coupled to 6/8/10' motor)				Weight (kg)
	A	B	C	φ D	
SJ150-1-1	1401/1360	870/800	531/560	144/148	92/117
SJ150-1	1561/1420	1030/860	531/560	144/148	100/124
SJ150-2-2	1781/1610	1090/890	691/720	144/148	119/141
SJ150-2-1	1851/1660	1160/940	691/720	144/148	128/156
SJ150-2	1921/1710	1230/990	691/720	144/148	135/166
SJ150-3-2	2181/1930/2042	1330/1050/1162	851/880/880	144/184/236	149/188/228
SJ150-3-1	2421/2030/2042	1570/1150/1162	851/880/880	144/184/236	158/202/246
SJ150-3	2421/2030/2042	1570/1150/1162	851/880/880	144/184/236	158/202/246
SJ150-4-2	--2280/2232	--1240/1192	--1040/1040	--184/236	--225/274
SJ150-4-1	--2280/2232	--1240/1192	--1040/1040	--184/236	--225/274
SJ150-4	--2410/2312	--1370/1272	--1040/1040	--184/236	--245/307
SJ150-5-2	--2570/2472	--1370/1272	--1200/1200	--184/236	--253/315
SJ150-5-1	--2570/2472	--1370/1272	--1200/1200	--184/236	--253/315
SJ150-5	--2690/2532	--1490/1332	--1200/1200	--192/236	--280/333
SJ150-6-2	--2850/2692	--1490/1332	--1360/1360	--192/236	--288/341
SJ150-6-1	--2900/2782	--1540/1422	--1360/1360	--192/236	--298/379
SJ150-6	--2900/2782	--1540/1422	--1360/1360	--192/236	--298/379
SJ150-7-2	--3060/2942	--1540/1422	--1520/1520	--192/236	--306/387
SJ150-7-1	--3164/3051	--1644/1531	--1520/1520	--192/236	--326/400
SJ150-7	--3164/3051	--1644/1531	--1520/1520	--192/236	--326/400
SJ150-8-2	--3324/3211	--1644/1531	--1680/1680	--192/236	--334/408
SJ150-8-1	--3444/3321	--1764/1641	--1680/1680	--192/236	--360/426
SJ150-8	--3444/3321	--1764/1641	--1680/1680	--192/236	--360/426
SJ150-9-2	--3604/3481	--1764/1641	--1840/1840	--192/236	--369/435
SJ150-9-1	--3604/3481	--1764/1641	--1840/1840	--192/236	--369/435
SJ150-9	--3604/3481	--1764/1641	--1840/1840	--192/236	--369/435

Note: The size B is varied with the motors of different manufacturers.

● Performance curve

ISO9906 Annex A 3440rpm

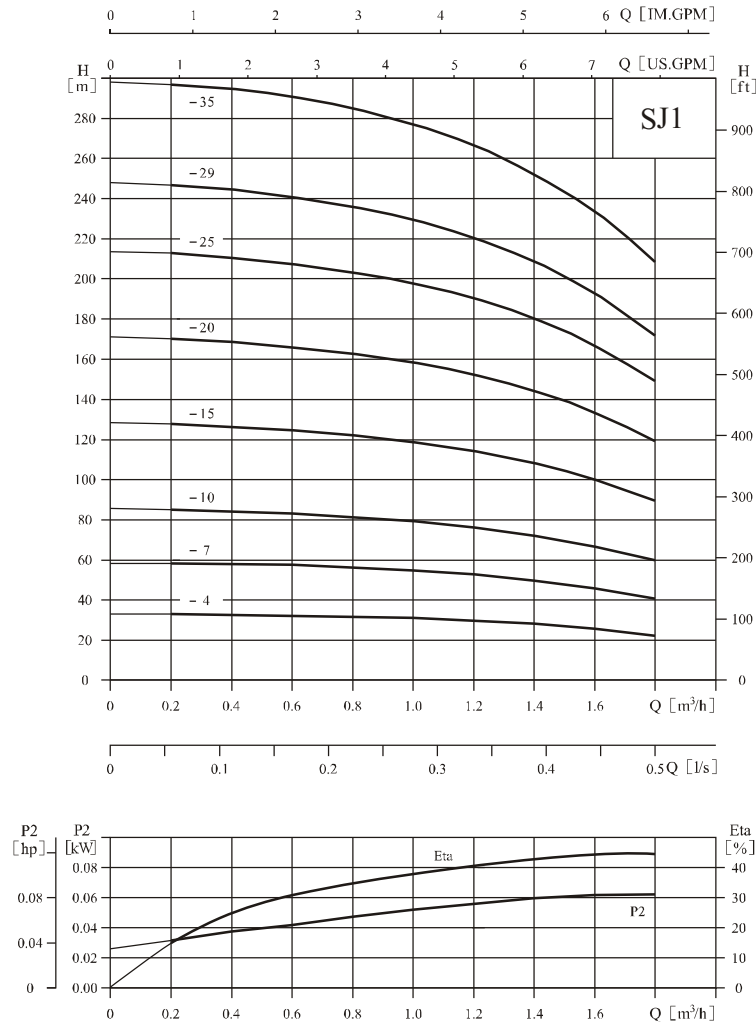

● Performance table

Model	Driving motor		Q (m³/h)	H (m)										
	(kW)	(hp)		0.2	0.4	0.6	0.8	1.0	1.2	1.4	1.6	1.8		
SJ1-4	0.37	0.5		33	32.5	32	31.5	31	29.5	28	25.5	22.5		
SJ1-7	0.55	0.75		58.5	58	57.5	56	55	53	50	46	41		
SJ1-10	0.75	1		85	84	83	81	79	75	71	66	59		
SJ1-15	1.1	1.5		127	126	125	123	118	114	108	100	89		
SJ1-20	1.5	2		170	168	166	163	158	152	144	133	119		
SJ1-25	2.2	3		213	211	207	203	198	190	180	167	149		
SJ1-29	2.2	3		247	244	241	236	230	221	209	193	172		
SJ1-35	3.0	4		297	295	291	285	277	267	252	234	209		

● Installation sketch

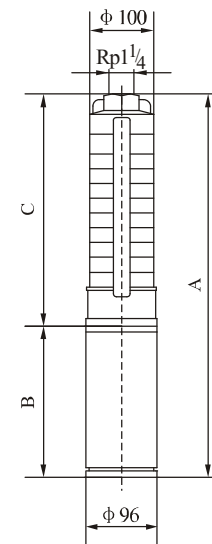

● Size and weight

Model	Size (mm)			Weight (kg)
	A	B	C	
SJ1-4	625	370	255	12
SJ1-7	698	380	318	14
SJ1-10	781	400	381	16
SJ1-15	926	440	486	18
SJ1-20	1061	470	591	22
SJ1-25	1206	510	696	27
SJ1-29	1290	510	780	28
SJ1-35	1526	620	906	30

Note: The size B is varied with the motors of different manufacturers.

● Performance curve

ISO9906 Annex A 3440rpm

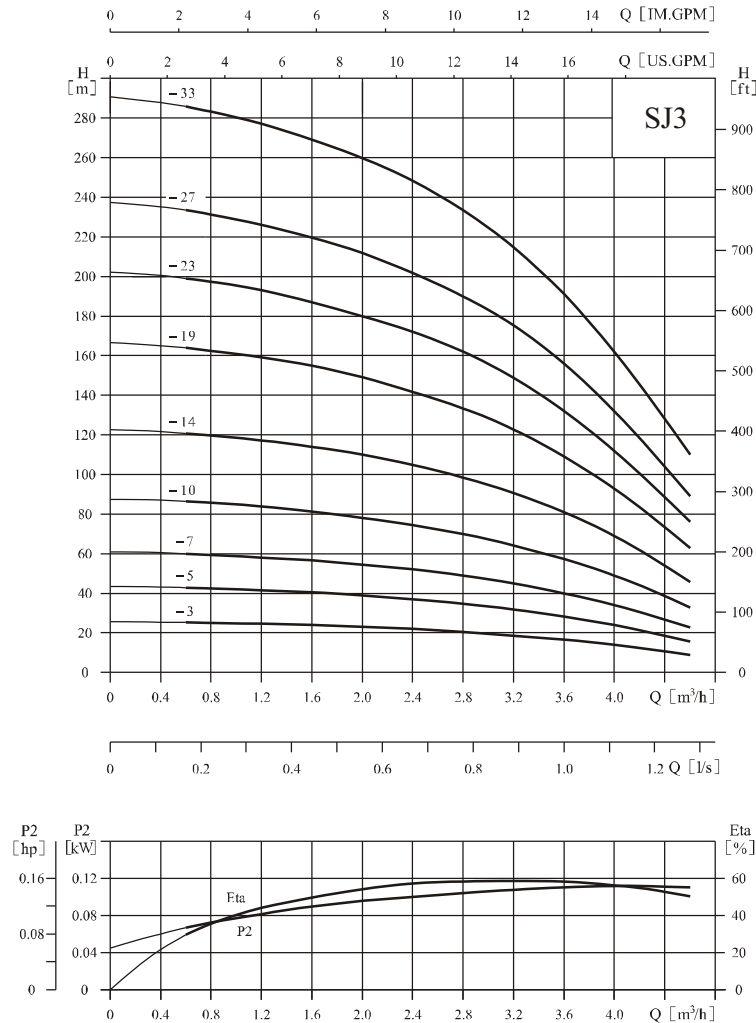

● Performance table

Model	Driving motor		Q (m³/h)	H (m)								
	(kW)	(hp)		0.6	1.2	1.6	2.0	2.4	3.0	3.6	4.0	4.6
SJ3-3	0.37	0.5		25	24.5	24	23	22	20	16.5	14	9
SJ3-5	0.55	0.75		43	41.5	40.5	39	37	34	28	24	16
SJ3-7	0.75	1		60	58	56.5	54.5	52	47	40	34	23
SJ3-10	1.1	1.5		86	84	81	78	74	68	57	49	33
SJ3-14	1.5	2		121	117	114	110	105	95	81	69	46
SJ3-19	2.2	3		164	159	155	149	142	129	109	93	63
SJ3-23	3	4		199	193	187	180	172	156	132	112	76
SJ3-27	3	4		233	226	220	212	202	183	156	132	89
SJ3-33	4	5.5		286	277	269	260	248	223	191	162	110

● Installation sketch

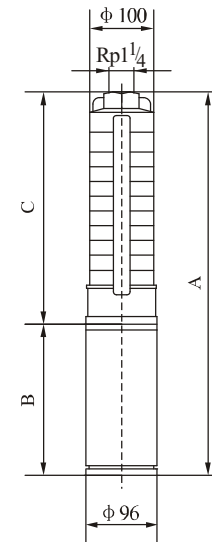

● Size and weight

Model	Size (mm)			Weight (kg)
	A	B	C	
SJ3-3	604	370	234	12
SJ3-5	656	380	276	13
SJ3-7	718	400	318	15
SJ3-10	821	440	381	17
SJ3-14	935	470	465	20
SJ3-19	1080	510	570	25
SJ3-23	1274	620	654	28
SJ3-27	1358	620	738	29
SJ3-33	1614	750	864	32

Note: The size B is varied with the motors of different manufacturers.

● Performance curve

ISO9906 Annex A 3440rpm

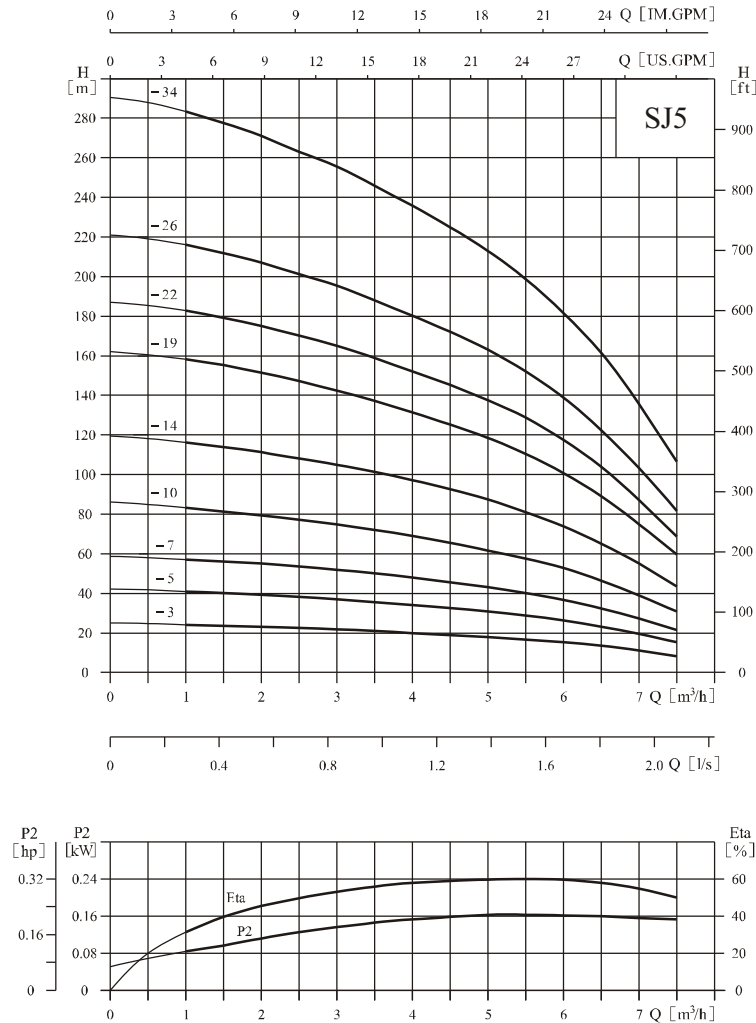

● Performance table

Model	Driving motor		Q (m³/h)	H (m)										
	(kW)	(hp)		1.0	2.0	3.0	3.5	4.0	4.5	5.0	5.5	6.0	7.0	7.5
SJ5-3	0.55	0.75		24	23	22	21	20	19	18	17	15.5	11.5	8.5
SJ5-5	0.75	1		41	39	37	35.5	34	32.5	31	29	26.5	19.5	15.5
SJ5-7	1.1	1.5		57	55	52	50	48	46	43	40	37	27	22
SJ5-10	1.5	2		83	79	75	72	69	66	62	58	53	39	31
SJ5-14	2.2	3		116	111	105	101	97	93	88	82	74	55	44
SJ5-19	3	4		158	151	143	137	131	125	119	111	101	75	60
SJ5-22	4	5.5		183	175	165	159	152	145	138	129	117	87	69
SJ5-26	4	5.5		216	207	196	188	180	172	163	152	139	103	82
SJ5-34	5.5	7.5		282	271	256	246	235	225	213	199	182	135	107

● Installation sketch

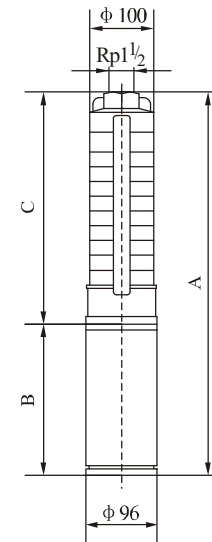

● Size and weight

Model	Size(mm)			Weight (kg)
	A	B	C	
SJ5-3	614	380	234	12
SJ5-5	676	400	276	14
SJ5-7	758	440	318	16
SJ5-10	851	470	381	19
SJ5-14	975	510	465	24
SJ5-19	1190	620	570	27
SJ5-22	1383	750	633	29
SJ5-26	1467	750	717	30
SJ5-34	1725	840	885	35

Note: The size B is varied with the motors of different manufacturers.

● Performance curve

ISO9906 Annex A 3440rpm

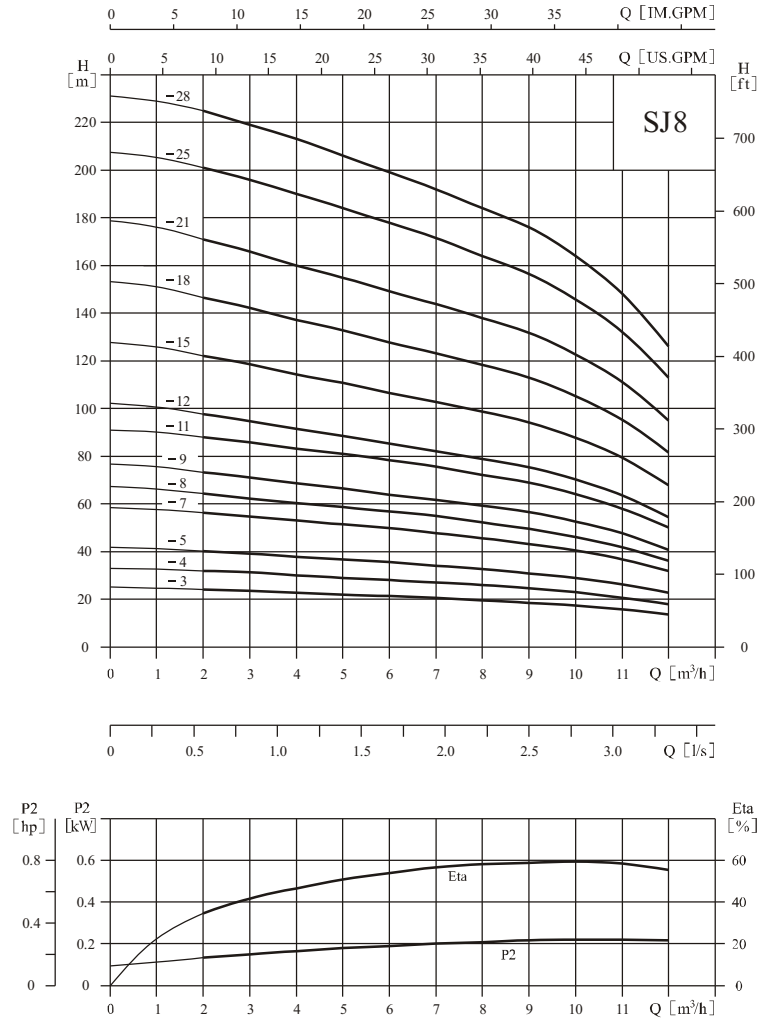

● Performance table

Model	Driving motor		Q (m³/h)	H (m)											
	(kW)	(hp)		2	3	4	5	6	7	8	9	10	11	12	
SJ8-3	1.1	1.5	24	23.5	22.5	22	21	20.5	19.5	18.5	17	15.5	13.5		
SJ8-4	1.1	1.5	32	31.5	30	29	28	27	26	24.5	23	20.5	18		
SJ8-5	1.5	2	40	39	38	36.5	35.5	34	32.5	31	29	26	22.5		
SJ8-7	2.2	3	56	55	53	51	50	48	46	43	40	37	32		
SJ8-8	2.2	3	64	62	60	58	57	55	52	49	46	42	36		
SJ8-9	3	4	72	70	68	66	64	62	59	56	53	48	41		
SJ8-11	3	4	88	86	83	81	79	76	72	69	64	58	50		
SJ8-12	4	5.5	97	94	91	89	86	83	79	75	70	63	54		
SJ8-15	4	5.5	121	118	114	111	107	103	98	94	88	79	68		
SJ8-18	5.5	7.5	147	142	137	133	128	124	118	113	105	95	81		
SJ8-21	5.5	7.5	171	166	160	155	149	144	138	132	123	111	95		
SJ8-25	7.5	10	201	196	190	184	177	172	164	157	146	132	113		
SJ8-28	7.5	10	225	219	213	206	199	192	184	176	164	148	126		

● Installation sketch

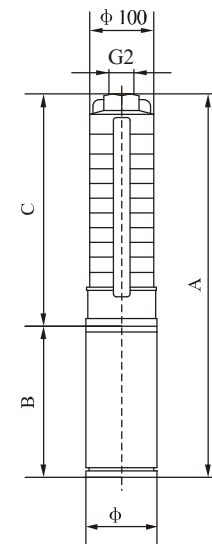

● Size and weight

Model	Size(mm)(Coupled to 4/6" motor)				Weight (kg)
	A	B	C	φ D	
SJ8-3	809	440	369	96	17
SJ8-4	851	440	411	96	18
SJ8-5	923	470	453	96	22
SJ8-7	1047	510	537	96	25
SJ8-8	1089	510	579	96	26
SJ8-9	1241	620	621	96	28
SJ8-11	1325	620	705	96	29
SJ8-12	1497	750	747	96/143	31/37
SJ8-15	1623	750	873	96/143	32/38
SJ8-18	1839	840	999	96/143	37/45
SJ8-21	1965	840	1125	96/143	39/47
SJ8-25	2213	920	1293	96/143	46/57
SJ8-28	2339	920	1419	96/143	47/58

Note: The size B is varied with the motors of different manufacturers.

● Performance curve

ISO9906 Annex A 3440rpm

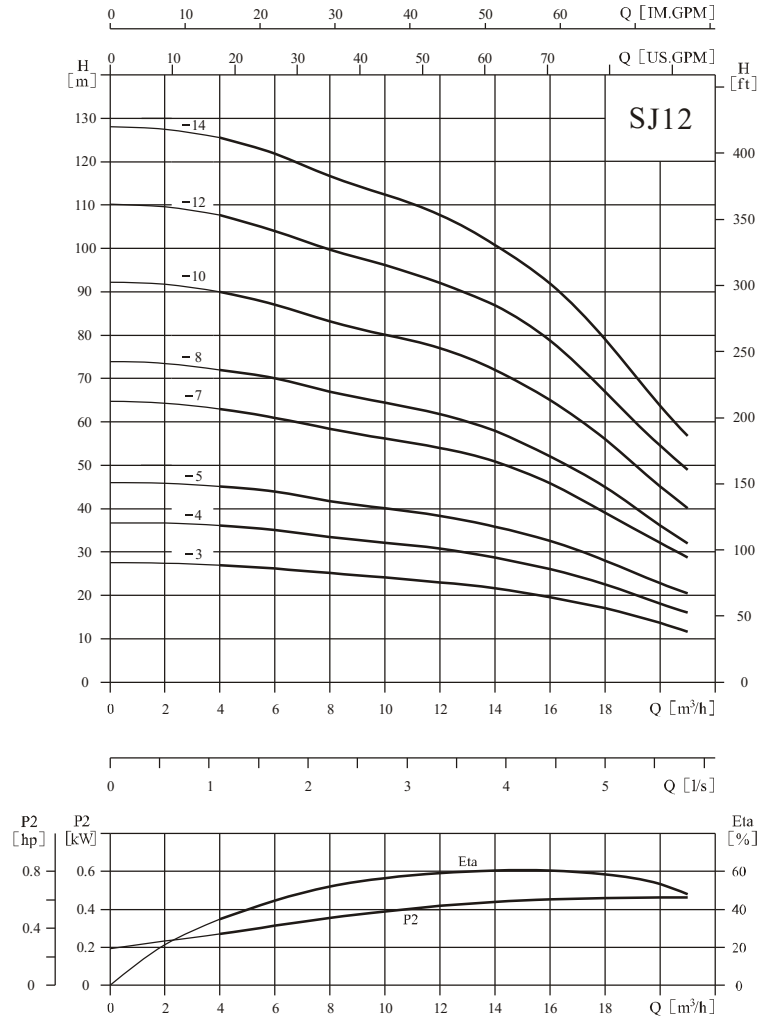

● Performance table

Model	Driving motor		Q (m³/h)	H (m)										
	(kW)	(hp)		4	6	8	10	12	14	16	18	20	21	
SJ12-3	2.2	3		27	26	25	24	23	22	19.5	17	13.5	12	
SJ12-4	2.2	3		36	35	33	32	31	29	26	22.5	18	16.5	
SJ12-5	3	4		45	44	41.5	40	38.5	36	32.5	28	22.5	21	
SJ12-7	4	5.5		63	61	58	56	54	51	46	39	32	28	
SJ12-8	5.5	7.5		72	70	66	64	62	58	52	45	36	32	
SJ12-10	5.5	7.5		90	87	83	80	77	72	65	56	45	40	
SJ12-12	7.5	10		108	104	99	96	92	87	79	67	54	49	
SJ12-14	7.5	10		126	122	116	112	108	101	92	79	63	57	

● Installation sketch

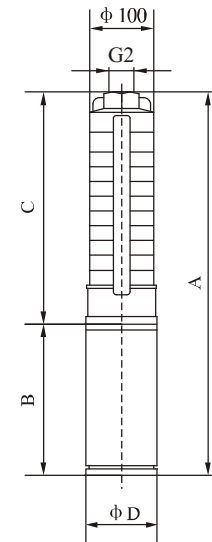

● Size and weight

Model	Size(mm)(Coupled to 4/6 motor)				Weight (kg)
	A	B	C	φ D	
SJ12-3	915	510	405	96	24
SJ12-4	980	510	470	96	25
SJ12-5	1155	620	535	96	28
SJ12-7	1415	750	665	96/143	29/35
SJ12-8	1570	840	730	96/143	35/43
SJ12-10	1700	840	860	96/143	36/44
SJ12-12	1910	920	990	96/143	42/53
SJ12-14	2040	920	1120	96/143	43/54

Note: The size B is varied with the motors of different manufacturers.

● Performance curve

ISO9906 Annex A 3440rpm

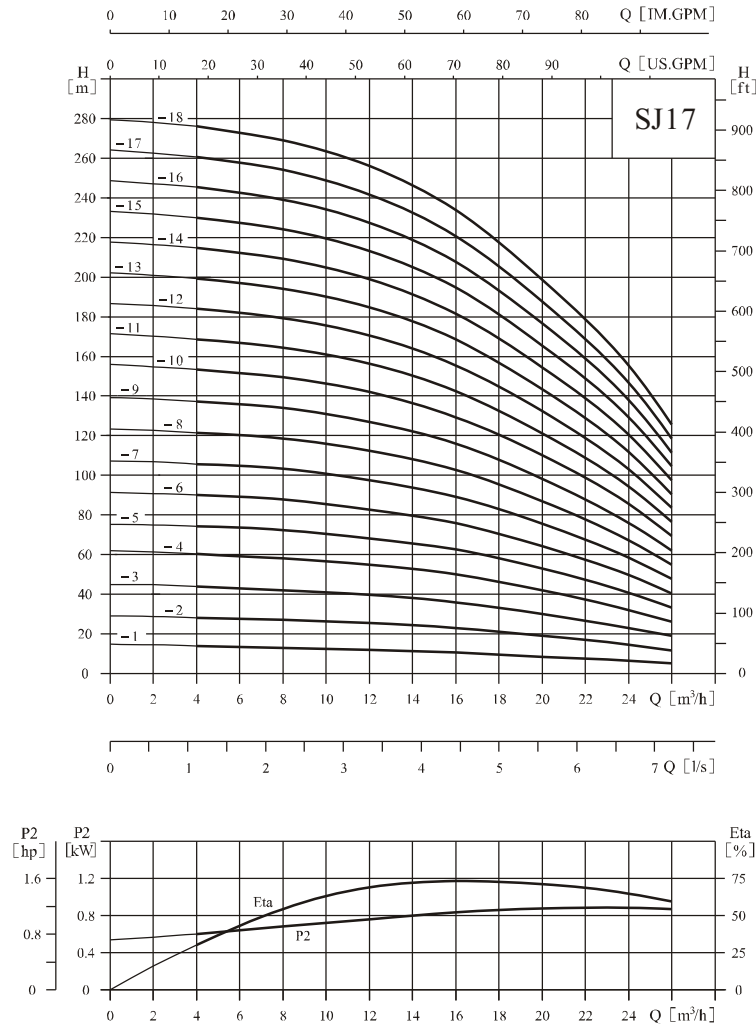

● Performance table

Model	Driving motor		Q (m³/h)	4	8	12	16	17	20	24	26
	(kW)	(hp)									
SJ17-1	1.1	1.5		14	13	12	10.5	10	8.5	6.5	5
SJ17-2	2.2	3		28	27	25.5	23	22	19	14.5	11.5
SJ17-3	3.0	4		44	42	40	36	35	30	23	19
SJ17-4	4.0	5.5		60	58	55	50	48	42	32	26
SJ17-5	5.5	7.5		75	73	69	63	61	53	41	33
SJ17-6	7.5	10		90	88	83	76	74	64	50	40
SJ17-7	7.5	10		106	103	98	89	87	75	59	48
SJ17-8	9.2	12.5		121	119	113	102	100	86	68	55
SJ17-9	9.2	12.5		137	134	127	116	112	97	77	62
SJ17-10	11	15		153	149	142	129	125	108	86	69
SJ17-11	11	15		168	164	156	143	138	119	95	76
SJ17-12	13	17.5		183	179	171	156	151	131	104	84
SJ17-13	13	17.5		199	194	185	170	164	142	113	91
SJ17-14	15	20		214	209	199	183	177	153	121	98
SJ17-15	15	20		229	224	214	196	189	164	130	105
SJ17-16	18.5	25		244	239	228	209	202	175	139	112
SJ17-17	18.5	25		260	254	242	222	214	186	147	119
SJ17-18	18.5	25		275	269	256	235	227	197	156	126

● Installation sketch

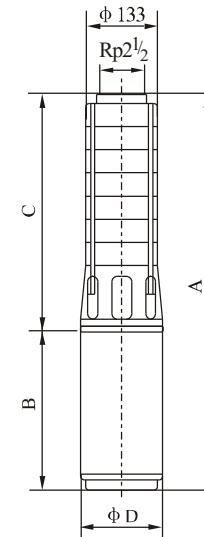

● Size and weight

Model	Size(mm)(Coupled to 4/6" motor)				Weight (kg)
	A	B	C	φ D	
SJ17-1	767	440	327	96	20
SJ17-2	898	510	388	96	27
SJ17-3	1068	620	448	96	30
SJ17-4	1259	750	509	96/143	33/39
SJ17-5	1409	840	569	96/143	37/45
SJ17-6	1550	920	630	96/143	43/54
SJ17-7	1610	920	690	96/143	44/55
SJ17-8	1621	870	751	143	62
SJ17-9	1681	870	811	143	63
SJ17-10	1808	920	888	143	77
SJ17-11	1868	920	948	143	78
SJ17-12	1989	980	1009	143	87
SJ17-13	2049	980	1069	143	88
SJ17-14	2160	1030	1130	143	95
SJ17-15	2230	1030	1190	143	96
SJ17-16	2341	1090	1251	143	104
SJ17-17	2401	1090	1311	143	105
SJ17-18	2462	1090	1372	143	106

Note: The size B is varied with the motors of different manufacturers.

● Performance curve

ISO9906 Annex A 3440rpm

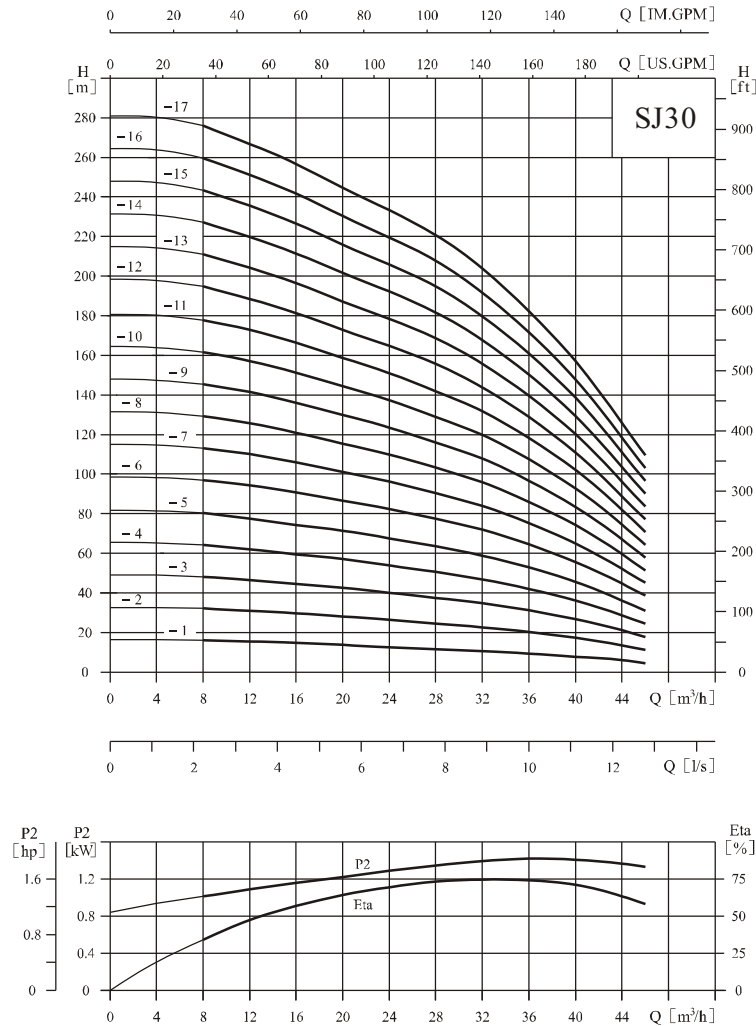

● Performance table

Model	Driving motor		Q (m³/h)	8	12	16	20	24	28	30	32	36	40	44	46
	(kW)	(hp)													
SJ30-1	1.5	2		16	15.5	15	13.5	13	12	11	10.5	9.5	7.5	6	4.5
SJ30-2	3.0	4		32	31	29	27	26	24.5	23.5	23	20.5	17	13	11.5
SJ30-3	5.5	7.5		48	46	45	42	39	37	36	34	31	26.5	21	17.5
SJ30-4	7.5	10		64	62	60	57	53	50	49	47	42	36	29	25
SJ30-5	7.5	10		81	77	74	72	67	64	62	59	53	46	36	31
SJ30-6	9.2	12.5		97	94	90	86	82	78	75	72	64	55	45	39
SJ30-7	11	15		113	110	105	100	96	90	88	84	75	65	52	45
SJ30-8	13	17.5		129	125	120	114	109	103	100	96	86	74	60	52
SJ30-9	15	20		145	141	135	129	123	116	113	108	96	83	67	58
SJ30-10	15	20		162	157	150	143	137	129	125	120	107	92	74	65
SJ30-11	18.5	25		178	173	166	158	151	142	138	132	118	102	82	71
SJ30-12	18.5	25		195	188	181	172	164	156	150	144	128	111	89	77
SJ30-13	22	30		211	203	196	187	178	169	163	156	139	120	97	84
SJ30-14	22	30		227	219	211	201	192	182	175	168	150	129	104	90
SJ30-15	25	34		244	235	226	215	206	195	188	180	161	138	112	97
SJ30-16	25	34		260	250	241	230	219	208	200	192	171	148	119	103
SJ30-17	25	34		276	266	256	244	233	221	213	204	182	157	126	110

● Installation sketch

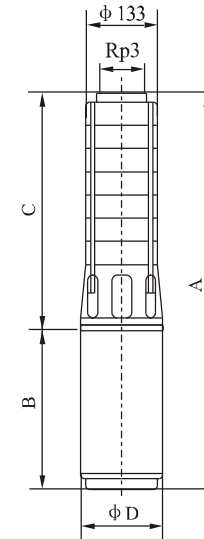

● Size and weight

Model	Size(mm)(Coupled to 4"/6" motor)				Weight (kg)
	A	B	C	ϕD	
SJ30-1	832	470	362	96	22
SJ30-2	1078	620	458	96	29
SJ30-3	1394	840	554	96/143	37/45
SJ30-4	1570	920	650	96/143	44/55
SJ30-5	1666	920	746	96/143	45/56
SJ30-6	1728	870	858	143	69
SJ30-7	1874	920	954	143	77
SJ30-8	2030	980	1050	143	86
SJ30-9	2176	1030	1146	143	93
SJ30-10	2272	1030	1242	143	95
SJ30-11	2428	1090	1338	143	103
SJ30-12	2524	1090	1434	143	105
SJ30-13	2690	1160	1530	143	121
SJ30-14	2786	1160	1626	143	123
SJ30-15	2952	1230	1722	143	135
SJ30-16	3048	1230	1818	143	137
SJ30-17	2144	1230	1914	143	139

Note: The size B is varied with the motors of different manufacturers.

● Performance curve

ISO9906 Annex A 3440rpm

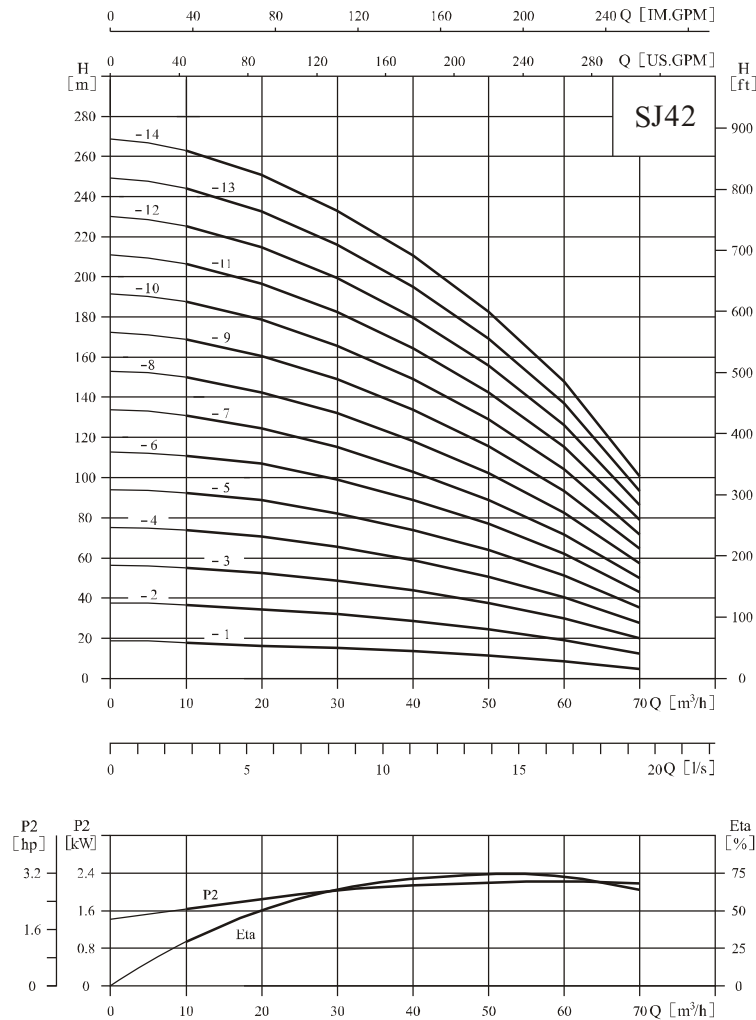

● Performance table

Model	Driving motor		Q (m³/h)	10	20	30	40	42	50	60	70
	(kW)	(hp)									
SJ42-1	3.0	4	17	16.5	15	13.5	13	11.5	8.5	5	
SJ42-2	5.5	7.5	36	34	31.5	28.5	28	24.5	19	12.5	
SJ42-3	9.2	12.5	55	52.5	48	44	43	38	30	20	
SJ42-4	11	15	74	70	65	58	57	51	40	27	
SJ42-5	13	17.5	93	88	82	73	72	64	51	35	
SJ42-6	18.5	25	111	107	99	89	87	77	62	43	
SJ42-7	18.5	25	131	125	116	105	102	91	73	50	
SJ42-8	22	30	150	143	133	120	117	104	84	56	
SJ42-9	25	34	168	161	149	135	131	117	94	64	
SJ42-10	30	40	187	179	166	150	146	131	105	72	
SJ42-11	30	40	206	197	182	165	161	144	116	79	
SJ42-12	37	50	225	215	199	180	176	157	126	87	
SJ42-13	37	50	244	233	216	196	191	170	137	94	
SJ42-14	37	50	263	251	233	211	206	183	148	101	

● Installation sketch

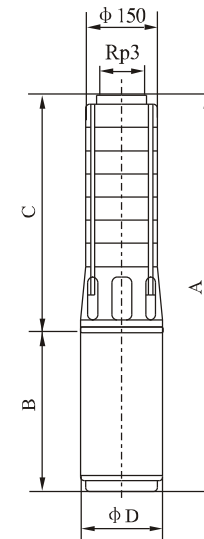

● Size and weight

Model	Size(mm)(Coupled to 4/6' motor)				Weight (kg)
	A	B	C	Φ D	
SJ42-1	998	620	378	96	31
SJ42-2	1331	840	491	96/143	38/46
SJ42-3	1474	870	604	143	67
SJ42-4	1653	920	733	143	75
SJ42-5	1826	980	846	143	83
SJ42-6	2049	1090	959	143	98
SJ42-7	2162	1090	1072	143	100
SJ42-8	2345	1160	1185	143	117
SJ42-9	2528	1230	1298	143	125
SJ42-10	2741	1330	1411	143	141
SJ42-11	2854	1330	1524	143	143
SJ42-12	3207	1570	1637	143	173
SJ42-13	3320	1570	1750	143	175
SJ42-14	3433	1570	1863	143	177

Note: The size B is varied with the motors of different manufacturers.

● Performance curve

ISO9906 Annex A 3440rpm

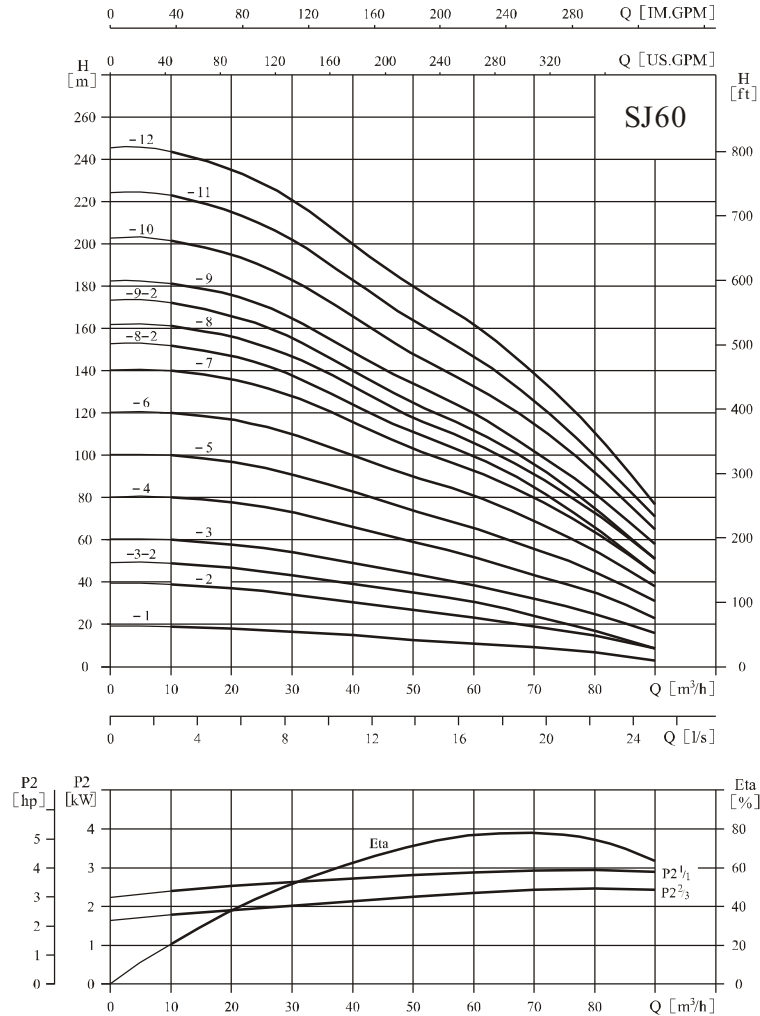

● Performance table

Model	Driving motor		Q (m³/h)	10	20	30	40	50	60	70	80	90
	(kW)	(hp)										
SJ60-1	4	5.5		19	18	16.5	15	12.5	11	9.5	7	3
SJ60-2	7.5	10		39	37	34	30	27	23.5	19	15	8.5
SJ60-3-2	7.5	10		49	47	43	39	35	31	24	17	8.5
SJ60-3	9.2	12.5		60	58	54	49	44	39	32	25	16
SJ60-4	13	17.5		80	78	73	66	59	52	43	35	23
SJ60-5	15	20		100	97	91	83	74	66	56	45	31
SJ60-6	18.5	25		120	117	110	100	90	81	69	55	38
SJ60-7	22	30		140	136	128	116	103	93	80	64	44
SJ60-8-2	22	30		152	147	138	124	111	100	85	66	44
SJ60-8	25	34		161	156	147	133	118	106	91	73	51
SJ60-9-2	25	34		172	166	156	140	125	112	96	75	51
SJ60-9	30	40		181	176	165	149	134	120	102	82	58
SJ60-10	30	40		202	195	183	166	149	133	115	92	65
SJ60-11	37	50		223	215	202	183	164	147	126	100	71
SJ60-12	37	50		244	235	221	200	180	162	139	111	77

● Installation sketch

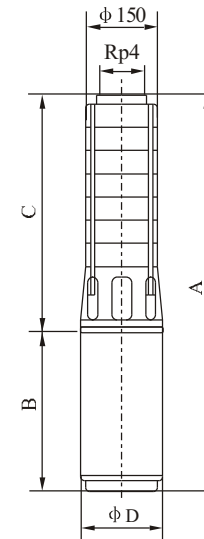

● Size and weight

Model	Size(mm)(Coupled to 4/6' motor)				Weight (kg)
	A	B	C	ϕD	
SJ60-1	1108	750	358	96/143	36/44
SJ60-2	1381	920	471	96/143	44/62
SJ60-3-2	1404	920	584	96/143	45/63
SJ60-3	1480	870	610	143	67
SJ60-4	1703	980	723	143	81
SJ60-5	1866	1030	836	143	89
SJ60-6	2039	1090	949	143	98
SJ60-7	2222	1160	1062	143	114
SJ60-8-2	2335	1160	1175	143	116
SJ60-8	2405	1230	1175	143	128
SJ60-9-2	2518	1230	1288	143	130
SJ60-9	2618	1330	1288	143	144
SJ60-10	2787	1330	1401	143	146
SJ60-11	3084	1570	1514	143	171
SJ60-12	3197	1570	1627	143	173

Note: The size B is varied with the motors of different manufacturers.

● Performance curve

ISO9906 Annex A 3500rpm

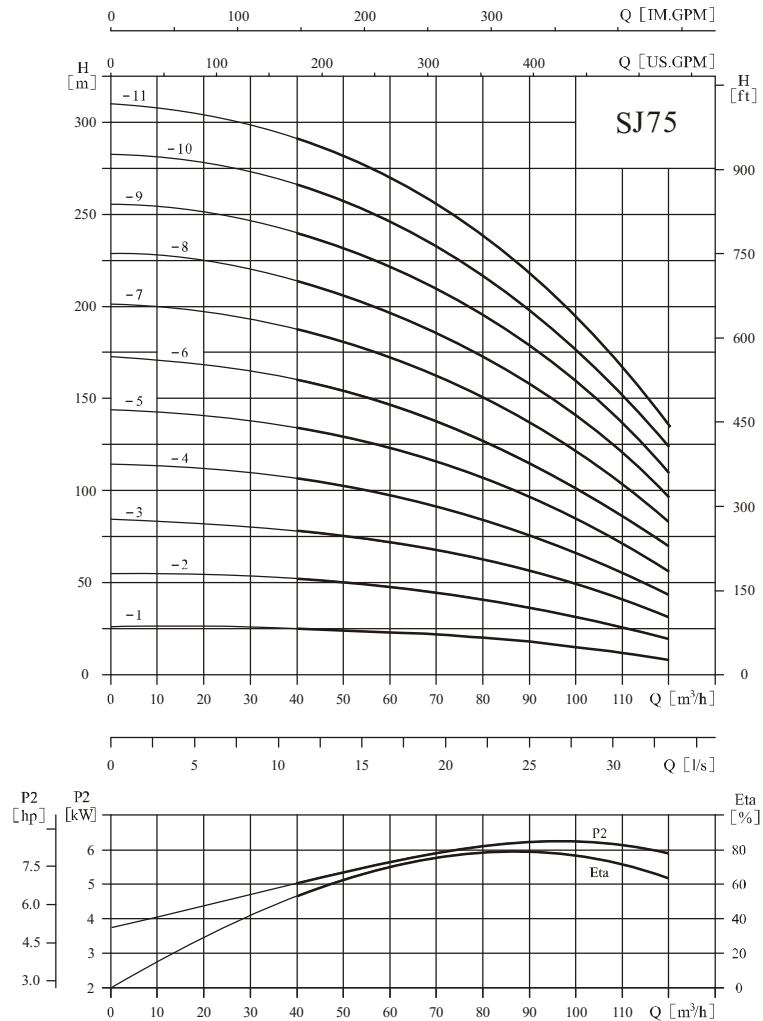

● Performance table

Model	Driving motor		Q (m³/h)	H (m)										
	(kW)	(hp)		40	50	60	70	75	80	90	100	110	120	
SJ75-1	7.5	10	25	24	23	22	21	20	18	15	12	8		
SJ75-2	13	17.5	52	50	47	44	42.5	40.5	36.5	32	26.5	19.5		
SJ75-3	22	30	78.5	75.5	71.5	67	65	62	56	49	41	31.5		
SJ75-4	30	40	107	103	98	91	88	84	77	68	57	44		
SJ75-5	37	50	134	129	122	114	110	106	96	84	72	57		
SJ75-6	45	60	160	154	146	137	132	126	115	102	87	70		
SJ75-7	45	60	188	181	173	161	155	149	136	121	104	83		
SJ75-8	55	75	214	207	197	184	178	171	156	140	121	97		
SJ75-9	63	85	240	232	221	208	201	194	177	158	136	110		
SJ75-10	75	100	267	258	247	232	224	217	198	177	152	123		
SJ75-11	75	100	292	283	270	255	246	238	217	194	168	135		

● Installation sketch

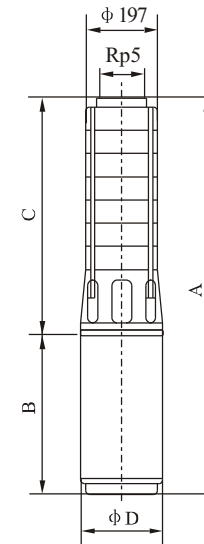

● Size and weight

Model	Size(mm)(Coupled to 6/8" motor)				Weight (kg)
	A	B	C	φ D	
SJ75-1	1298/1285	810/780	488/505	143/184	70/79
SJ75-2	1594/1491	980/860	614/631	143/184	94/123
SJ75-3	1900/1697	1160/940	740/757	143/184	126/162
SJ75-4	2196/1933	1330/1050	866/883	143/184	156/195
SJ75-5	2562/2159	1570/1150	992/1009	143/184	184/212
SJ75-6	2375	1240	1135	184	229
SJ75-7	2501	1240	1261	184	235
SJ75-8	2757	1370	1387	184	253
SJ75-9	3003	1490	1513	192	272
SJ75-10	3179	1540	1639	192	298
SJ75-11	3305	1540	1765	192	304

Note: The size B is varied with the motors of different manufacturers.

Performance curve

ISO9906 Annex A 3500rpm

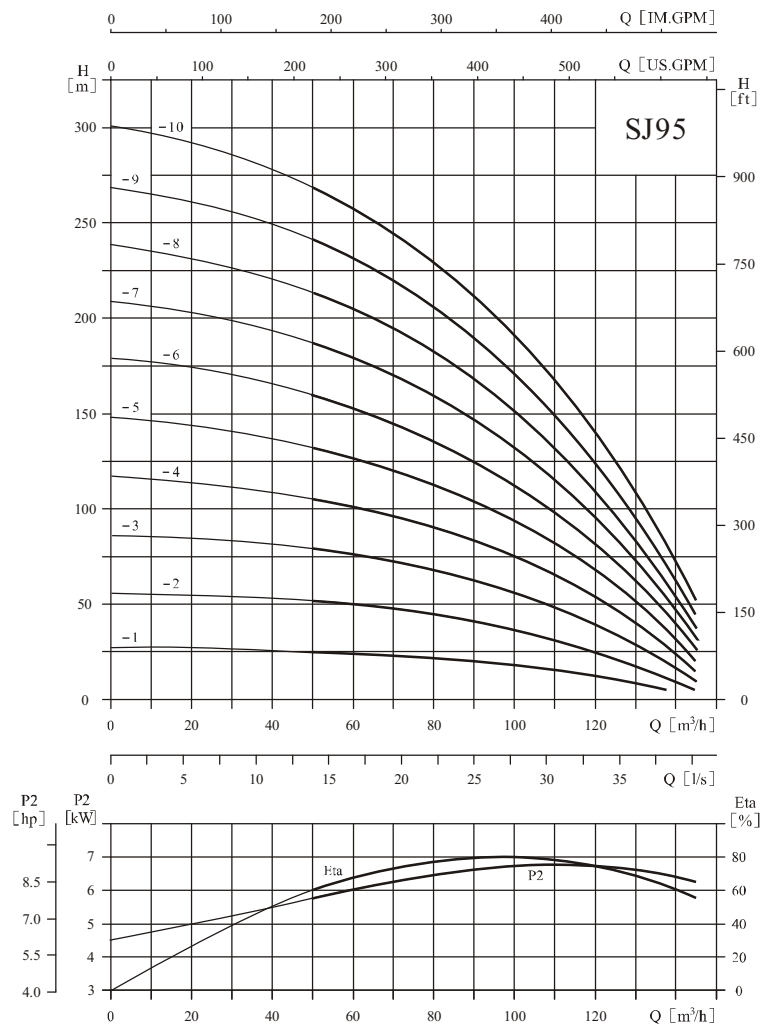

Performance table

Model	Driving motor		Q (m³/h)	H (m)										
	(kW)	(hp)		50	60	70	80	90	95	100	110	120	130	145
SJ95-1	7.5	10	25	24	23	21.5	20	18.5	17	15	12	8.5	—	
SJ95-2	15	20	52	50.5	48	44.5	40.5	38	36	31	25.5	19.5	5	
SJ95-3	22	30	78.5	75.5	72	67	62	59	55.5	47.5	39	30	9	
SJ95-4	30	40	105	102	96	90	83	79	75	65	53	41	15	
SJ95-5	37	50	133	127	121	113	104	99	94	81	67	51	20	
SJ95-6	45	60	160	153	145	136	125	119	113	98	82	63	26	
SJ95-7	55	75	187	179	170	173	146	140	132	116	96	73	32	
SJ95-8	63	85	214	205	194	182	167	159	151	132	110	84	37	
SJ95-9	63	85	242	232	219	204	188	180	171	150	125	95	45	
SJ95-10	75	100	269	258	244	228	210	201	191	168	140	107	52	

Installation sketch

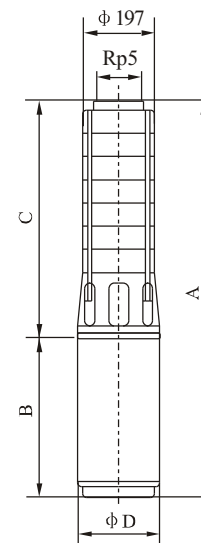

Size and weight

Model	Size(mm)(Coupled to 6/8' motor)				Weight (kg)
	A	B	C	phi D	
SJ95-1	1298/1285	810/780	488/505	143/184	71/80
SJ95-2	1644/1491	1030/860	614/631	143/184	101/124
SJ95-3	1900/1697	1160/940	740/757	143/184	127/163
SJ95-4	2196/1933	1330/1050	866/883	143/184	158/196
SJ95-5	2562/2159	1570/1150	992/1009	143/184	186/214
SJ95-6	2375	1240	1135	184	232
SJ95-7	2631	1370	1261	184	250
SJ95-8	2877	1490	1387	192	270
SJ95-9	3003	1490	1513	192	276
SJ95-10	3179	1540	1639	192	302

Note: The size B is varied with the motors of different manufacturers.

● Performance curve

ISO9906 Annex A 3500rpm

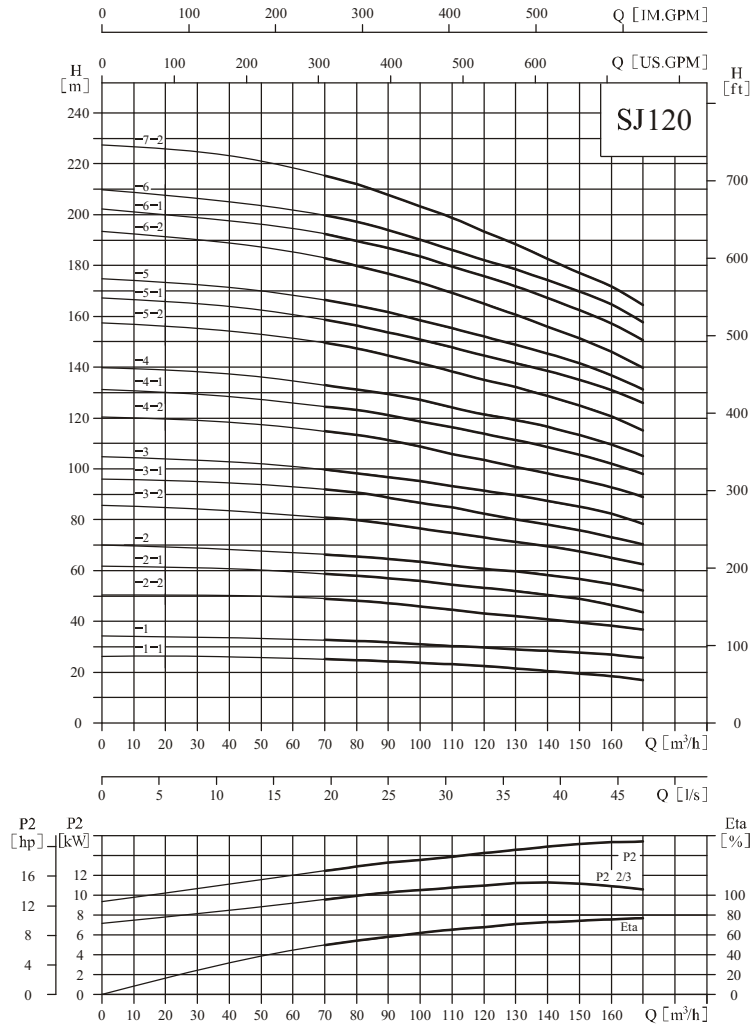

● Performance table

Model	Driving motor		Q (m³/h)	H (m)											
	(kW)	(hp)		70	80	90	100	110	120	130	140	150	160	170	
SJ120-1-1	15	20	25	24.5	24	23.5	23	22	21.5	20.5	19.5	18.5	16.5		
SJ120-1	18.5	25	32.5	32	31.5	31	30	29.5	29	28	27.5	26.5	25.5		
SJ120-2-2	25	30	48.5	48	47	45.5	44.5	43	42	40.5	39.5	38	36.5		
SJ120-2-1	30	40	58.5	57.5	57	55.5	54	53	51.5	50.5	48.9	46.5	43.5		
SJ120-2	37	50	66	65.5	64.5	63	61.5	60.5	59.5	58	56.5	54.5	52		
SJ120-3-2	45	60	80.5	79.5	78	76.5	74.5	73	71	69.5	67.5	65	62.5		
SJ120-3-1	45	60	91.5	90.5	88.5	86.5	84.5	82	80	78	75.5	73	70		
SJ120-3	55	75	99.5	98	96.5	95	93	91	89.5	87	85	82	78.5		
SJ120-4-2	63	85	114.5	113	111	108.5	105.5	103	100.5	98	95.5	92.5	89		
SJ120-4-1	63	85	124.5	123	121	118.5	116	113.5	111	108.5	105.5	102	98		
SJ120-4	75	100	132.5	131	129	127	124	121.5	119	116.5	113	109.5	105		
SJ120-5-2	75	100	149.5	147	144.5	141.5	138	135	132	128.5	124.5	120.5	115		
SJ120-5-1	90	120	158.5	156	153	150.5	147.5	144.5	141.5	138.5	135	131	126		
SJ120-5	90	120	166	164	161.5	158.5	155	152	148.5	145	141.5	136.5	131		
SJ120-6-2	90	120	182.5	179.5	176.5	173	169	164.5	160.5	156	151	146	139.5		
SJ120-6-1	110	150	192.5	189.5	186.5	183.5	179.5	175.5	171.5	167	162	157	150.5		
SJ120-6	110	150	199.5	197	193.5	190	186	182	178	174	169.5	164.5	159.5		
SJ120-7-2	110	150	215	211.5	207.5	203	198.5	193.5	188	182.5	177	171.5	164		

● Installation sketch

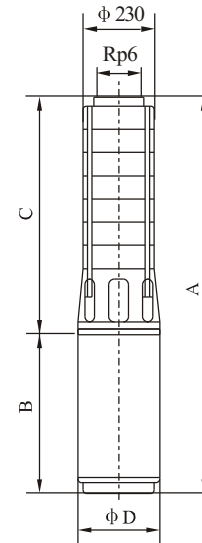

● Size and weight

Model	Size(mm)(Coupled to 6/8/10' motor)				Weight (kg)
	A	B	C	φ D	
SJ120-1-1	1561/1420/--	1030/860/--	531/560/--	144/184/--	103/127/--
SJ120-1	1621/1450/--	1090/890/--	531/560/--	144/184/--	110/132/--
SJ120-2-2	1921/1710/--	1230/990/--	691/720/--	144/184/--	134/165/--
SJ120-2-1	2021/1770/1842	1330/1050/1122	691/720/720	144/184/236	140/179/219
SJ120-2	2261/1870/1882	1570/1150/1162	691/720/720	144/184/236	149/193/237
SJ120-3-2	--/2120/2072	--/1240/1192	--/880/880	--/184/236	--/216/265
SJ120-3-1	--/2120/2072	--/1240/1192	--/880/880	--/184/236	--/216/265
SJ120-3	--/2250/2152	--/1370/1272	--/880/880	--/184/236	--/232/298
SJ120-4-2	--/2530/2372	--/1490/1332	--/1040/1040	--/184/236	--/272/325
SJ120-4-1	--/2530/2372	--/1490/1332	--/1040/1040	--/184/236	--/272/325
SJ120-4	--/2580/2462	--/1540/1422	--/1040/1040	--/184/236	--/282/363
SJ120-5-2	--/2740/2622	--/1540/1422	--/1200/1200	--/184/236	--/290/371
SJ120-5-1	--/2844/2751	--/1644/1531	--/1200/1200	--/184/236	--/310/384
SJ120-5	--/2844/2751	--/1644/1531	--/1200/1200	--/184/236	--/318/384
SJ120-6-2	--/3004/2891	--/1644/1531	--/1360/1360	--/184/236	--/318/392
SJ120-6-1	--/3124/3001	--/1764/1641	--/1360/1360	--/184/236	--/344/429
SJ120-6	--/3124/3001	--/1764/1641	--/1360/1360	--/192/236	--/344/429
SJ120-7-2	--/3284/3161	--/1764/1641	--/1520/1520	--/192/236	--/352/437

Note: The size B is varied with the motors of different manufacturers.

● Performance curve

ISO9906 Annex A 3500rpm

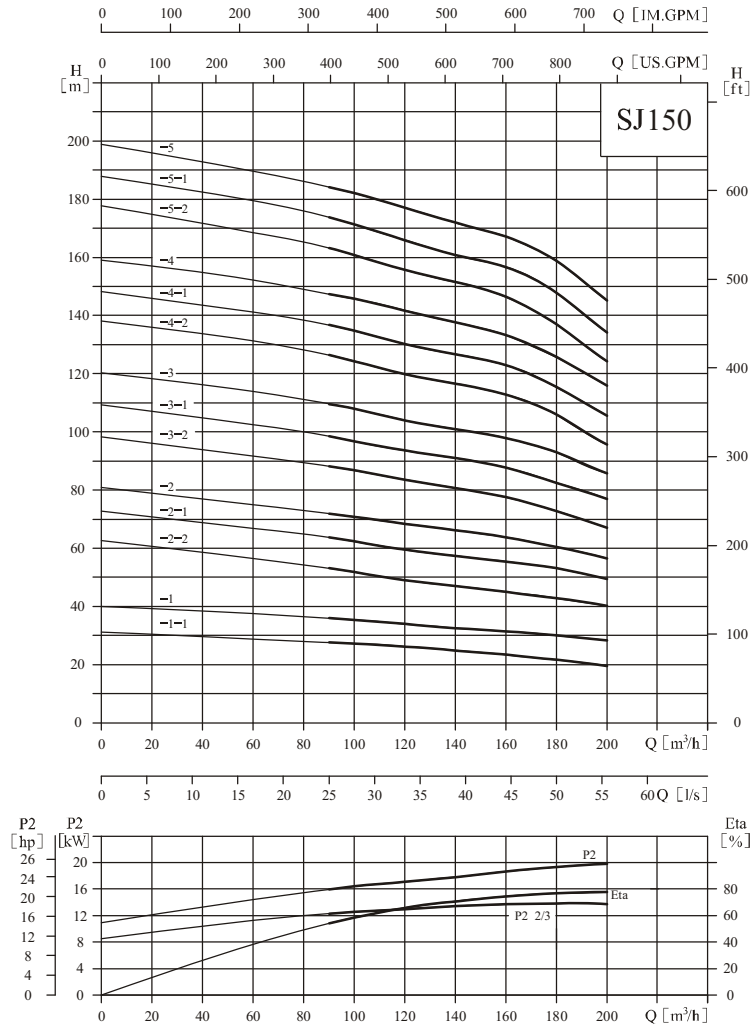

● Performance table

Model	Driving motor		Q (m³/h)	90	100	120	140	150	160	180	200
	(kW)	(hp)									
SJ150-1-1	15	20		27.5	27	26	24.5	24	23	21.5	19.5
SJ150-1	22	30		36	35	33.5	32.5	32	31.5	30	28
SJ150-2-2	30	40		53	51.5	49	47	46	45	42.5	40
SJ150-2-1	37	50		63.5	62	59.5	57	56	55	53	49
SJ150-2	45	60		71.5	70.5	68	66	65	63.5	60	56.5
SJ150-3-2	55	75		88	86.5	83.5	80.5	79	77.5	72.5	67
SJ150-3-1	63	85		98.5	96.5	93.5	91	89.5	87.5	82.5	76.5
SJ150-3	63	85		109.5	107.5	104	101	99.5	97.5	92.5	85.5
SJ150-4-2	75	100		126	124	119.5	116.5	114.5	112.5	105.5	95.5
SJ150-4-1	90	120		136.5	134.5	130	126.5	125	122.5	115	105.5
SJ150-4	90	120		147	145.5	141.5	137.5	135.5	133	125.5	115.5
SJ150-5-2	110	150		163	160.5	155.5	151.5	149	146	136.5	124
SJ150-5-1	110	150		173.5	171	165.5	160.5	158.5	156.5	147.5	134
SJ150-5	110	150		184	182	177	171.5	169.5	167	158.5	145

● Installation sketch

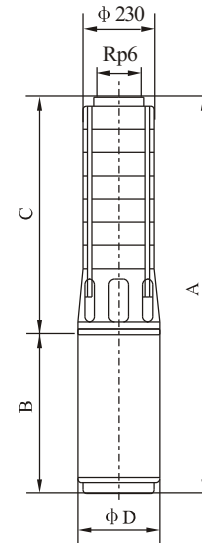

● Size and weight

Model	Size(mm)(Coupled to 6/8/10' motor)				Weight (kg)
	A	B	C	φ D	
SJ150-1-1	1561/1420/--	1030/860/--	531/560/--	144/184/--	103/127/--
SJ150-1	1691/1500/--	1160/940/--	531/560/--	144/184/--	119/147/--
SJ150-2-2	2021/1770/1842	1330/1050/1122	691/720/720	144/184/236	141/180/220
SJ150-2-1	2261/1870/1882	1570/1150/1162	691/720/720	144/184/236	150/194/237
SJ150-2	--/1960/1912	--/1240/1192	--/720/720	--/184/236	--/209/258
SJ150-3-2	--/2250/2152	--/1370/1272	--/880/880	--/184/236	--/237/299
SJ150-3-1	--/2370/2212	--/1490/1332	--/880/880	--/184/236	--/264/317
SJ150-3	--/2370/2212	--/1490/1332	--/880/880	--/184/236	--/264/317
SJ150-4-2	--/2580/2462	--/1540/1422	--/1040/1040	--/184/236	--/282/363
SJ150-4-1	--/2684/2571	--/1644/1531	--/1040/1040	--/184/236	--/302/376
SJ150-4	--/2684/2571	--/1644/1531	--/1040/1040	--/184/236	--/302/376
SJ150-5-2	--/2964/2841	--/1764/1641	--/1200/1200	--/184/236	--/336/421
SJ150-5-1	--/2964/2841	--/1764/1641	--/1200/1200	--/184/236	--/336/421
SJ150-5	--/2964/2841	--/1764/1641	--/1200/1200	--/192/236	--/336/421

Note: The size B is varied with the motors of different manufacturers.