



# NISO

50Hz  
End Suction Centrifugal Pump



Nanfang Pump Industry Co.,Ltd.

CNP Headquarter

Address: Renhe Town, Hangzhou China

PostCode: 311107

Tel: +86 571 86397810, 86397838

Fax: +86 571 86397809

E-mail: [info@nanfang-pump.com](mailto:info@nanfang-pump.com)

<http://www.cnppump.com>

E111205  
subject to amendments



# Company Profile



Founded in 1991, Nanfang Pump Industry Co., Ltd. (hereinafter referred to as CNP) has been listed on the Shenzhen Stock Exchange on 9th December 2010; Stock name: CNP; Stock code: 300145.

As the first enterprise specializing in the research and large-scale production of stainless steel stamping welded centrifugal pump in China, CNP is currently the professional manufacturer with the highest volume of production and marketing in that industry. It ranks first in the country in terms of product scope, sales volume, and production quality. The company has set up a complete network of marketing services to meet the requirements of overseas markets as well as domestic needs. The products have seen a wide range of application in the area of pressurization, industry, living water, cycling of air-conditioning water, heat supply, fire extinguishing system, pumping of underground water, treatment of sewage and waste water, chemical industry and desalination of sea water etc.

CNP has now entered into the fast track of development and has taken a major step forward in forging China Strong Pump Enterprise and World's famous brand in the Pump Industry. In order to better meet the client's needs and requirements for expansion, it has set up a wide network of selling and service, as well as offices and service centers in major cities in China, which are aimed at providing timely and effective services for our clients. Meanwhile, our company has successfully penetrated into the world market by forging a good business relationship with more than 50 countries and regions in the Europe, Northern American, and Southeast Asia etc.

# Content

## General Data

Definition of Model	3
Min inlet pressure	3
Typical application	3
Construction	3
Specification	3
Curve notes	3
Features	3
Model performance drawing	4
Sectional drawing	5
Part list	5
Models	6

## Technical Data

2 Pole	
NISO50-32-160/NISO50-32-200	10
NISO65-40-200/NISO65-40-250	11
NISO65-40-315/NISO65-50-160	12
NISO80-50-200/NISO80-50-250	13
NISO80-50-315/NISO80-65-160	14
NISO100-65-200/NISO100-65-250	15
NISO100-65-315/NISO100-80-160	16
NISO125-100-200/NISO125-100-250	17
NISO125-100-315	18
4 Pole	
NISO50-32-160	18
NISO50-32-200/NISO65-40-200	19
NISO65-40-250/NISO65-40-315	20
NISO65-50-160/NISO80-50-200	21
NISO80-50-250/NISO80-50-315	22
NISO80-65-160/NISO100-65-200	23
NISO100-65-250/NISO100-65-315	24
NISO100-80-160/NISO125-100-200	25
NISO125-100-250/NISO125-100-315	26
NISO125-80-400/NISO125-100-400	27
NISO150-125-250/NISO150-125-315	28
NISO150-125-400/NISO200-150-315	29
NISO200-150-400/NISO250-200-315	30
NISO250-200-400	31
Pump dimensions	32
Pump dimension table	33
Pump set dimension	35
Pump set dimension table	35

## ● Definition of Model

NISO100-65-200/30

NISO 100 — 65 — 200 / 30

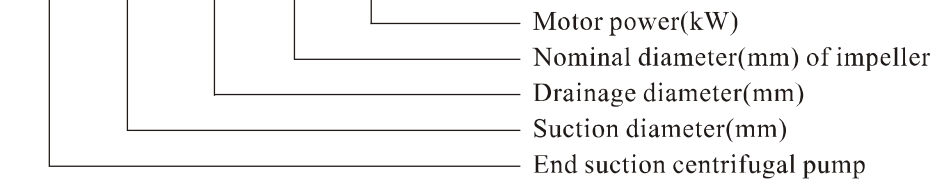

## ● Min inlet pressure

Min inlet pressure depends on NPSH +0.5m safety margin + gasified pressure. It should be re-calculated the inlet pressure if one of the following happens.

- The liquid is more warm.
- The flow exceeds the nominate value.
- Suction distance is very long or inlet pipe is very long.
- System pressure is too little.
- Inlet pressure is low.

## ● Typical application

- Clean, thin, non-corrosive, non-flammable or non-explosive liquid without grain or fiber.
- Water supply system
- Heat, air condition system
- Booster, constant pressure water supply
- Firefighting, splitting system
- Irrigating, farming
- Industry cooling, heater circulation system
- Industry transferring, drainage system

## ● Construction

- Non-self-priming, single stage, single suction, horizontal, axial suction and radical discharge, pump body is fixed by base.
- Use bearing cradle, which can orientate bearing, prevent from radical vibration, improve the rigidity of rotary part.
- Compacted shaft, use deep groove grease lubricated roller bearing.
- Connect pump and motor with semi-flexible coupling.
- Use standard wearable mechanical seal.
- TEFC motor, size complies to IEC standard, installation type B3.
- The dimensions is conform to ISO 2858

## ● Specification

- Flow: Max 800m<sup>3</sup>/h
- Head: Max 160m
- Working pressure: Max 16 bar
- Inlet pressure: Max 6 bar
- Power: Max 160kW
- Liquid temperature: -15°C ~ 110°C
- Inlet and Outlet diameter: Inlet diameter: DN50~DN250  
Outlet diameter: DN32~DN200

## ● Curve conditions

- Curves tolerance is according to ISO9906, Annex A;
- All curves are based on the measured value of constant motor speed 2900rpm, 2950rpm, 1450rpm or 1480rpm.
- The measurements were made with airless water at temperature of 20°C. The curves apply to a kinematic viscosity of 1mm<sup>2</sup>/s(1 cst)

## ● Features

- Back-pull-out design, without having to disturb pump body and pipelines when servicing.
- All the models only use 4 kinds of pump shafts and bearing cover, make parts exchangeable.
- Impeller is optimum design, inlet is enlarged, no whirlpool, deduct the water pump NPSH efficiently, which makes pump work stable with little noise.
- Casing and casing cover use wearing neck ring structure, which makes pump easy to maintain, makes parts work longer. The replaceable seal ring, makes pump work efficiently in a long time.

## ● Model performance drawing

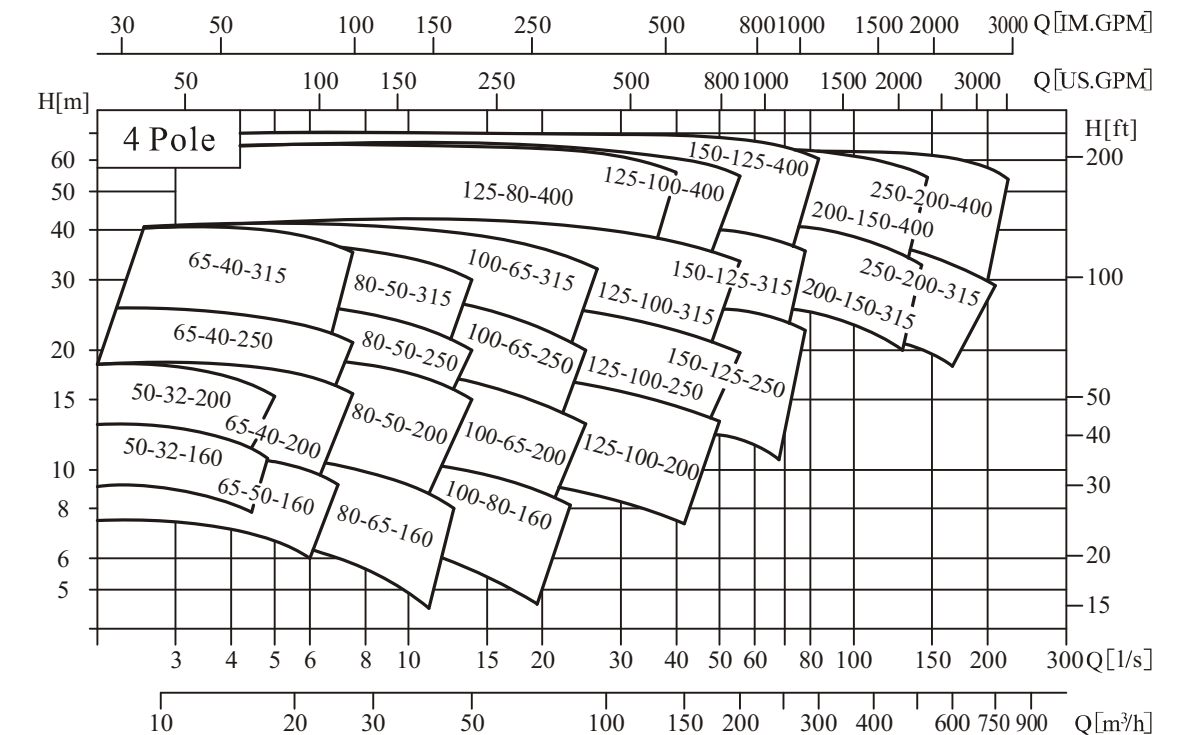
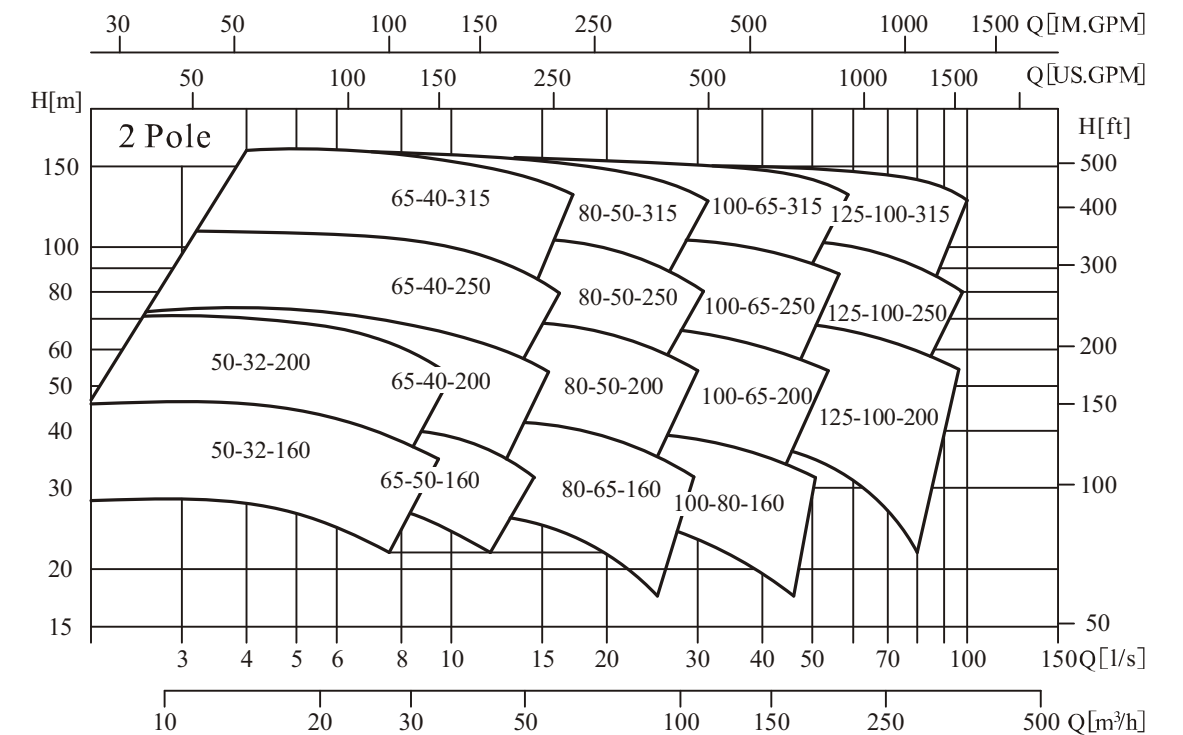

## Sectional drawing

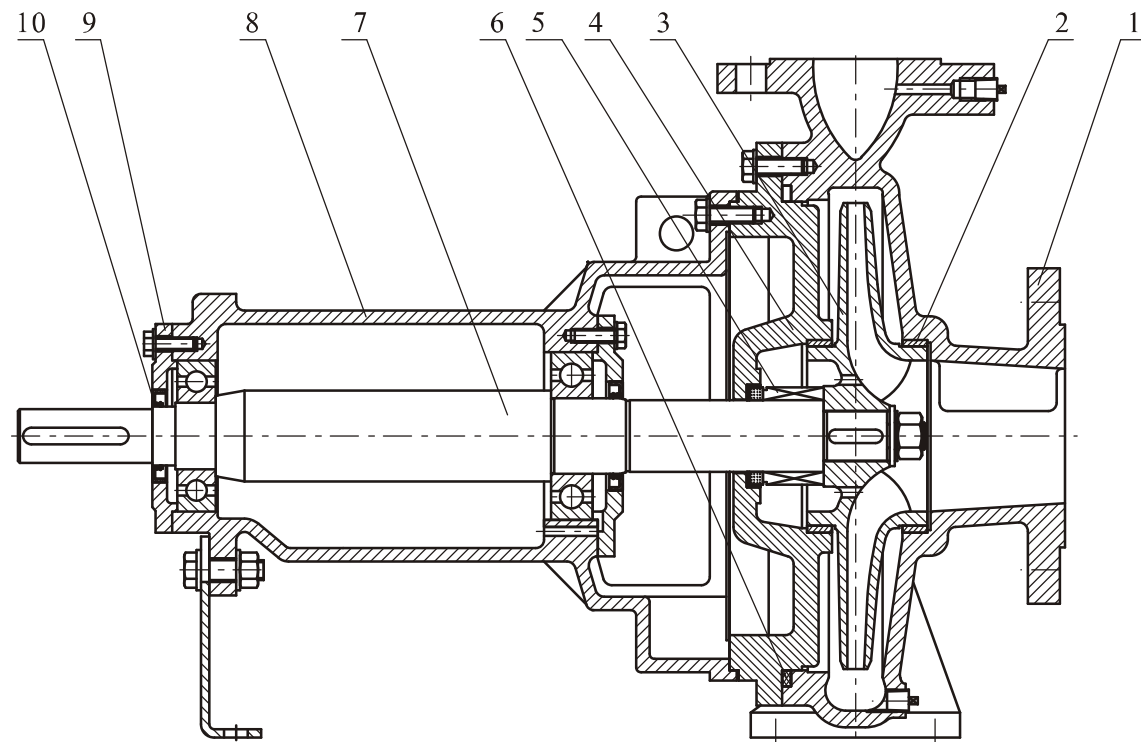

## Part list

No.	Name	Material	Code/AISI/ASTM
1	Casing	Cast Iron HT200	ASTM25B
2	Wear ring	Cast Iron HT200	ASTM25B
3	Impeller	Cast Iron HT200/SS OCr18Ni9	ASTM25B/AISI304
4	Casing cover	Cast Iron HT200	ASTM25B
5	Mechanical seal	Carbon/Silicon Carbide	
6	O ring	NBR	
7	Shaft	SS 2Cr13	AISI420
8	Bearing housing	Cast Iron HT200	ASTM25B
9	Bearing cover	Cast Iron HT200	ASTM25B
10	Seal	NBR	

## Models

2 Pole

No.	Model	Q [m³/h]	H [m]	Motor [kW]	n [r/min]
1	NISO 50-32-160/3	12.5	28	3	2900
2	NISO 50-32-160/4		36	4	
3	NISO 50-32-160/5.5		44	5.5	
4	NISO 50-32-200/7.5		55	7.5	
5	NISO 50-32-200/11		74	11	
6	NISO 65-40-200/7.5	25	48	7.5	2900
7	NISO 65-40-200/11		62	11	
8	NISO 65-40-200/15		72	15	
9	NISO 65-40-250/18.5		84	18.5	
10	NISO 65-40-250/22		95	22	
11	NISO 65-40-250/30		105	30	
12	NISO 65-40-315/22		105	22	
13	NISO 65-40-315/30		120	30	
14	NISO 65-40-315/37		145	37	
15	NISO 65-40-315/45		165	45	
16	NISO 65-50-160/4	50	28	4	2900
17	NISO 65-50-160/5.5		36	5.5	
18	NISO 65-50-160/7.5		42	7.5	
19	NISO 80-50-200/11		44	11	
20	NISO 80-50-200/15		57	15	
21	NISO 80-50-200/18.5		64	18.5	
22	NISO 80-50-200/22		71	22	
23	NISO 80-50-250/30		84	30	
24	NISO 80-50-250/37		100	37	
25	NISO 80-50-315/37		105	37	
26	NISO 80-50-315/45	125	45		
27	NISO 80-50-315/55	140	55		
28	NISO 80-50-315/75	152	75		

## ● Models

2 Pole

No.	Model	Q [m³/h]	H [m]	Motor [kW]	n [r/min]
29	NISO 80-65-160/5.5	50	22	5.5	2900
30	NISO 80-65-160/7.5		29	7.5	
31	NISO 80-65-160/11		38	11	2950
32	NISO 80-65-160/15		44	15	
33	NISO 100-65-200/18.5	100	36	18.5	2950
34	NISO 100-65-200/22		43	22	
35	NISO 100-65-200/30		56	30	
36	NISO 100-65-200/37		67	37	
37	NISO 100-65-250/45		80	45	
38	NISO 100-65-250/55		88	55	
39	NISO 100-65-250/75		108	75	
40	NISO 100-65-315/90		128	90	
41	NISO 100-65-315/110		148	110	
42	NISO 100-80-160/11		23	11	
43	NISO 100-80-160/15	30	15		
44	NISO 100-80-160/18.5	35	18.5		
45	NISO 100-80-160/22	40	22		
46	NISO 125-100-200/30	200	34	30	
47	NISO 125-100-200/37		41	37	
48	NISO 125-100-200/45		48	45	
49	NISO 125-100-200/55		55	55	
50	NISO 125-100-200/75		66	75	
51	NISO 125-100-250/75		75	75	
52	NISO 125-100-250/90		86	90	
53	NISO 125-100-250/110		100	110	
54	NISO 125-100-315/90		93	90	
55	NISO 125-100-315/110		108	110	
56	NISO 125-100-315/132	124	132	2950	
57	NISO 125-100-315/160	144	160		

## ● Models

4 Pole

No.	Model	Q [m³/h]	H [m]	Motor [kW]	n [r/min]	
1	NISO 50-32-160/0.55	6.3	8.5	0.55	1450	
2	NISO 50-32-160/0.75		11	0.75		
3	NISO 50-32-200/1.1		14	1.1		
4	NISO 50-32-200/1.5		18	1.5		
5	NISO 65-40-200/1.1	12.5	12	1.1	1450	
6	NISO 65-40-200/1.5		15	1.5		
7	NISO 65-40-200/2.2		17.5	2.2		
8	NISO 65-40-250/3		25	3		
9	NISO 65-40-315/4		34	4		
10	NISO 65-40-315/5.5		40	5.5		
11	NISO 65-50-160/0.55		7	0.55		
12	NISO 65-50-160/0.75		9	0.75		
13	NISO 65-50-160/1.1		10.5	1.1		
14	NISO 80-50-200/1.5		25	11		1.5
15	NISO 80-50-200/2.2	15		2.2		
16	NISO 80-50-200/3	17.5		3		
17	NISO 80-50-250/4	21		4		
18	NISO 80-50-250/5.5	25		5.5		
19	NISO 80-50-315/5.5	30		5.5		
20	NISO 80-50-315/7.5	37		7.5		
21	NISO 80-65-160/0.75	6		0.75		
22	NISO 80-65-160/1.1	8		1.1		
23	NISO 80-65-160/1.5	10.5		1.5		
24	NISO 100-65-200/3	50	11.5	3	1480	
25	NISO 100-65-200/4		14	4		
26	NISO 100-65-200/5.5		16	5.5		
27	NISO 100-65-250/5.5		20	5.5		
28	NISO 100-65-250/7.5		25	7.5		
29	NISO 100-65-315/11		32	11		
30	NISO 100-65-315/15		40	15		
31	NISO 100-80-160/1.5		6.5	1.5		1450
32	NISO 100-80-160/2.2		9	2.2		
33	NISO 100-80-160/3		10.5	3		

## Models

4 Pole

No.	Model	Q [m³/h]	H [m]	Motor [kW]	n [r/min]
34	NISO 125-80-400/15	50	39	15	1480
35	NISO 125-80-400/18.5		45	18.5	
36	NISO 125-80-400/22		50	22	
37	NISO 125-80-400/30		60	30	
38	NISO 125-80-400/37		67	37	
39	NISO 125-100-200/4	100	9	4	1450
40	NISO 125-100-200/5.5		11.5	5.5	
41	NISO 125-100-200/7.5		14	7.5	
42	NISO 125-100-200/11		16.5	11	
43	NISO 125-100-250/15		25	15	
44	NISO 125-100-315/11		23	11	
45	NISO 125-100-315/18.5		32	18.5	
46	NISO 125-100-315/22		36	22	
47	NISO 125-100-315/30		40	30	
48	NISO 125-100-400/30		50	30	
49	NISO 125-100-400/37	58	37		
50	NISO 125-100-400/45	65	45		
51	NISO150-125-250/11	200	12.5	11	1480
52	NISO150-125-250/15		16	15	
53	NISO150-125-250/18.5		20	18.5	
54	NISO150-125-250/22		24	22	
55	NISO150-125-315/30		32	30	
56	NISO150-125-315/37		39	37	
57	NISO150-125-400/45		50	45	
58	NISO150-125-400/55		57	55	
59	NISO150-125-400/75		68	75	
60	NISO200-150-315/37		400	23	
61	NISO200-150-315/45	27		45	
62	NISO200-150-315/55	32		55	
63	NISO200-150-315/75	38		75	
64	NISO200-150-400/75	43		75	
65	NISO200-150-400/90	50	90		
66	NISO200-150-400/110	62	110		
67	NISO250-200-315/37	500	20	37	
68	NISO250-200-315/45		23	45	
69	NISO250-200-315/55	630	24	55	
70	NISO250-200-315/75		32	75	
71	NISO250-200-400/90		37	90	
72	NISO250-200-400/110		44	110	
73	NISO250-200-400/132		53	132	
74	NISO250-200-400/160	60	160		

## NISO50-32-160/NISO50-32-200

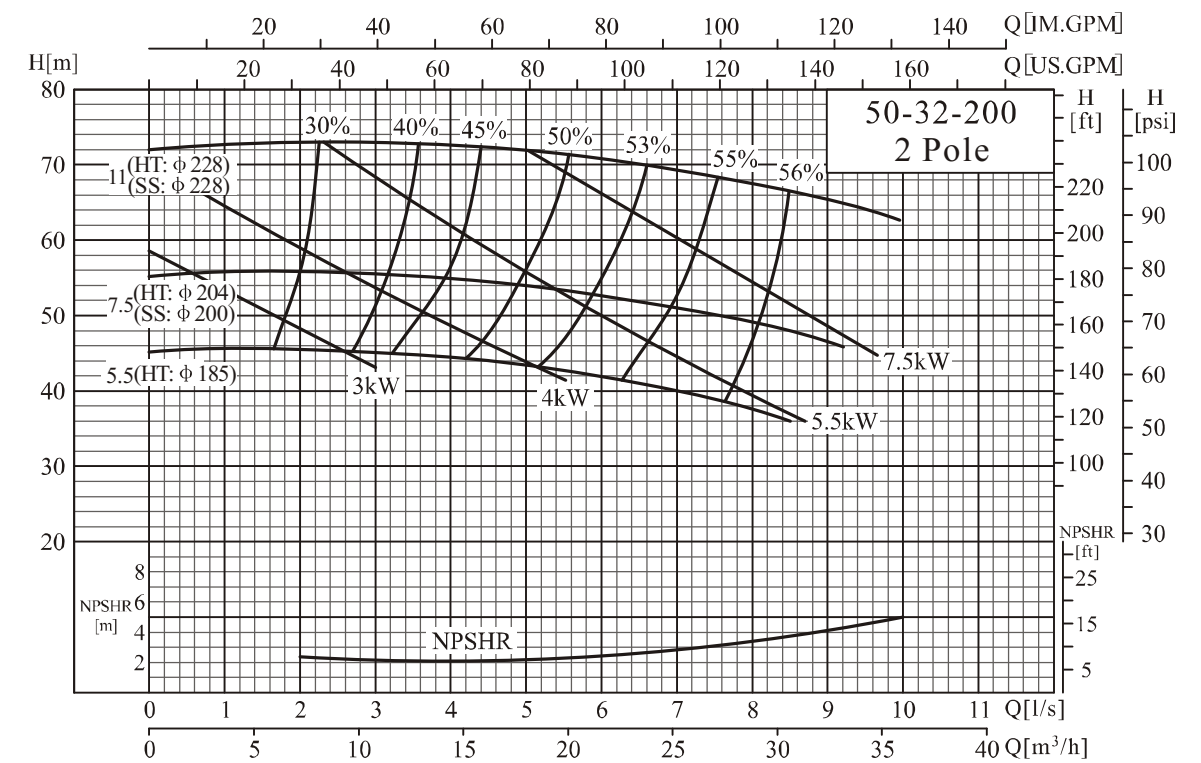
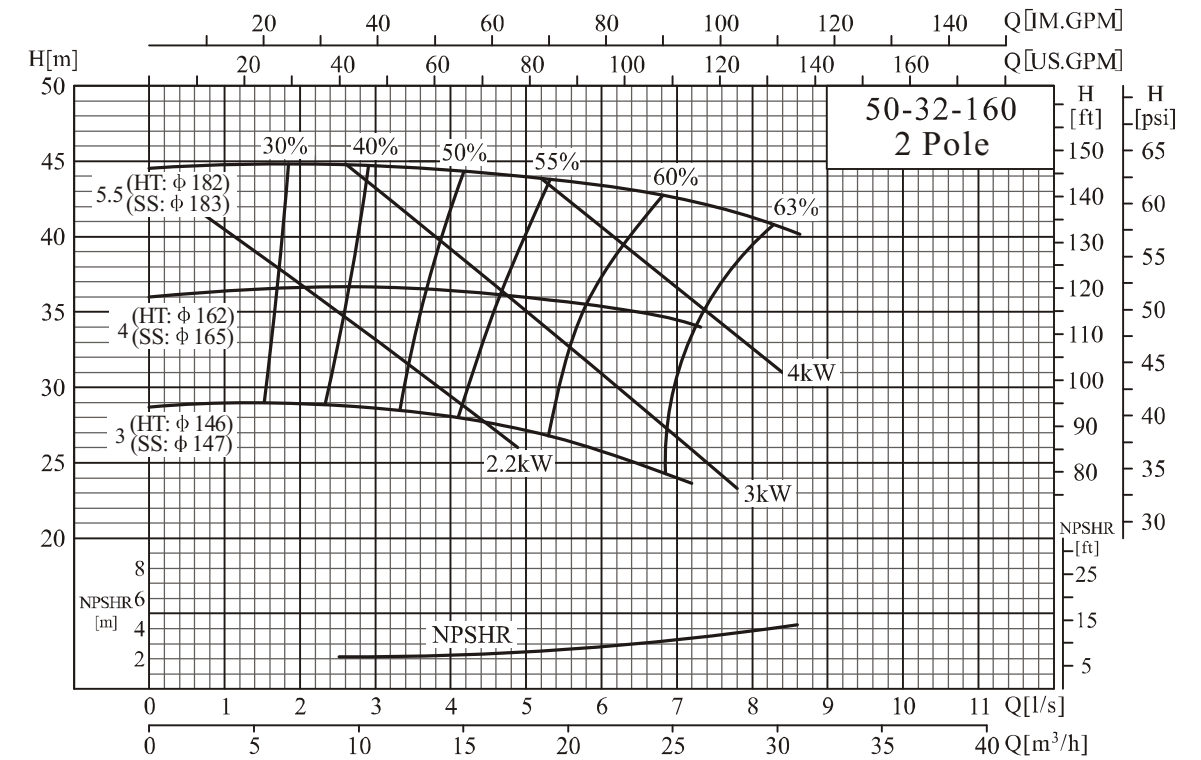

## ● NISO65-40-200/NISO65-40-250

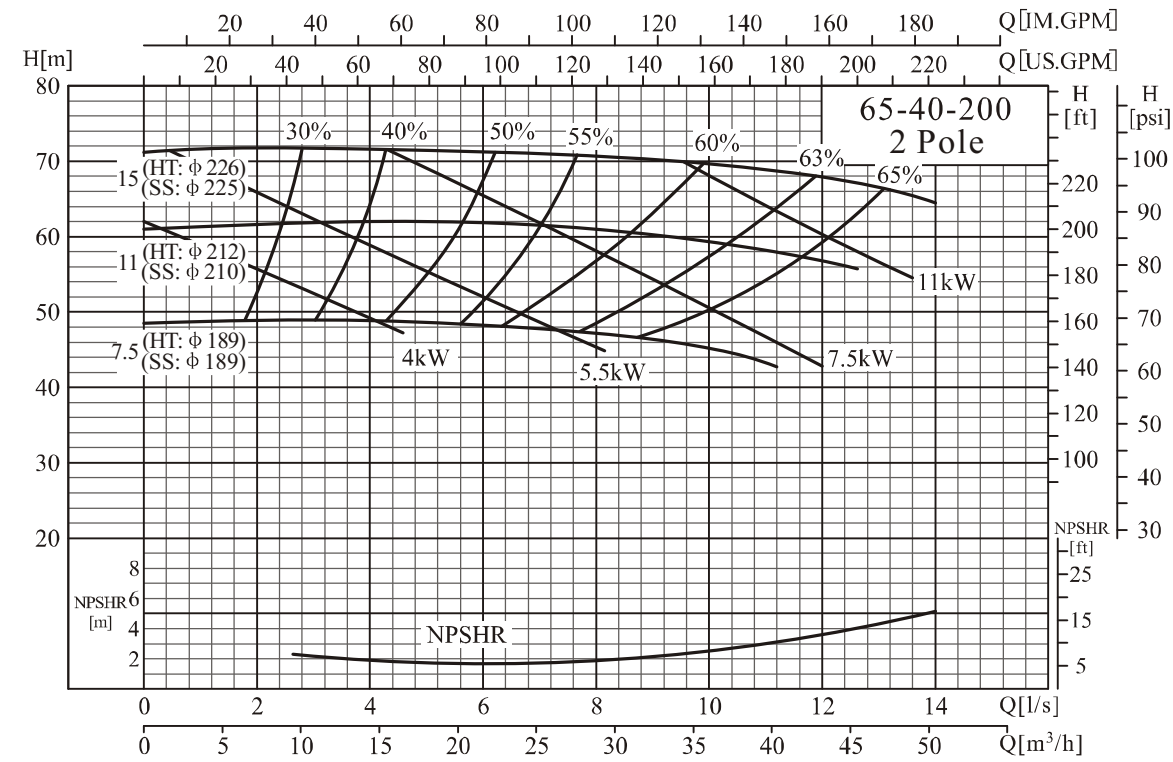

## ● NISO65-40-315/NISO65-50-160

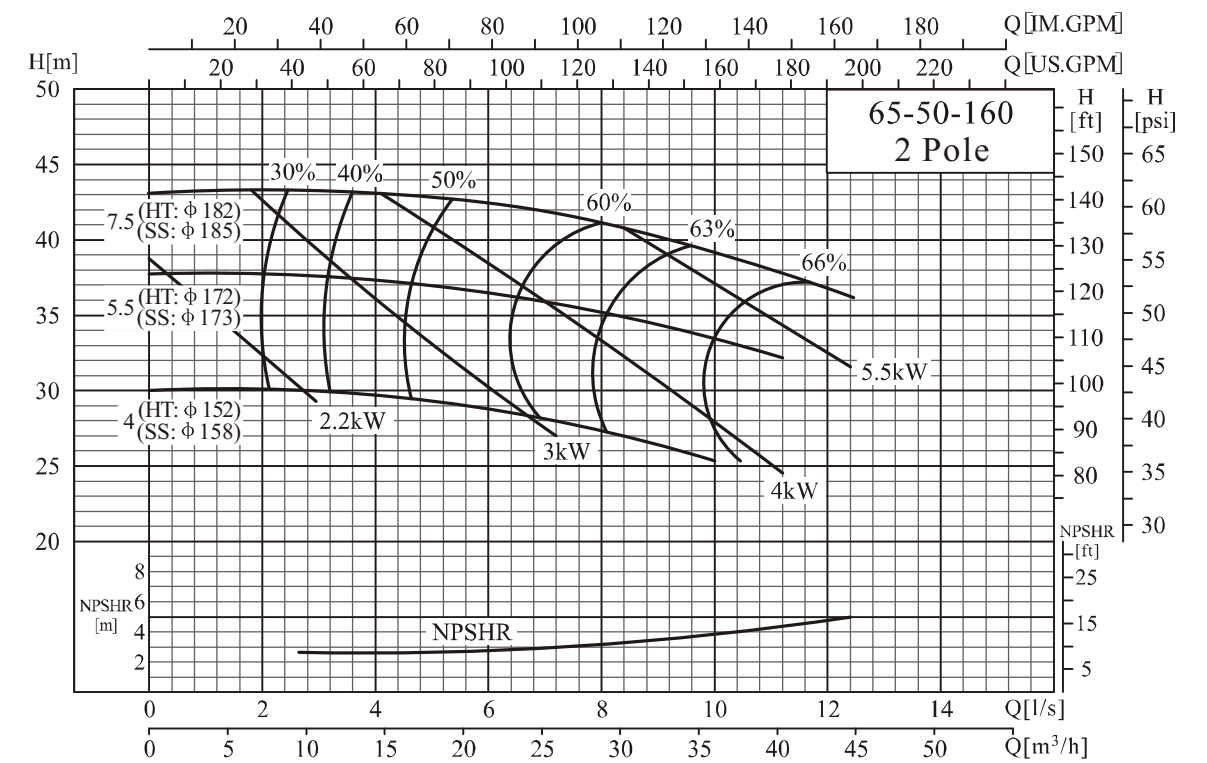
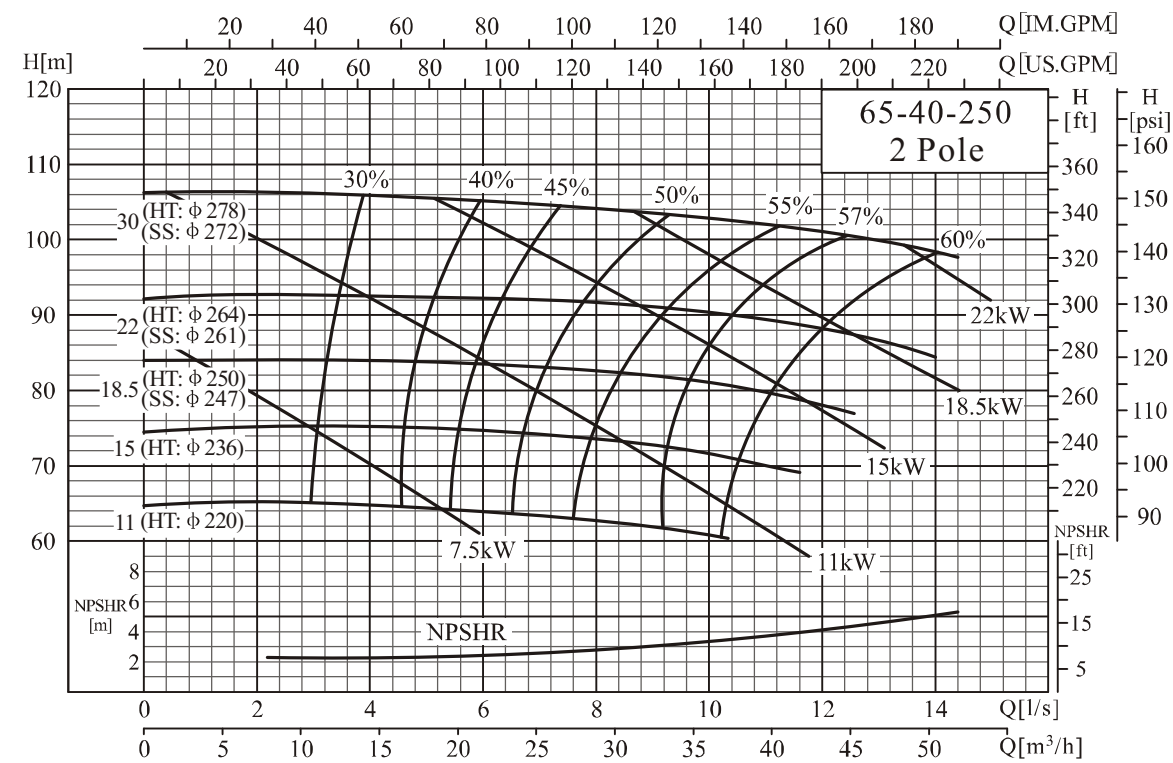
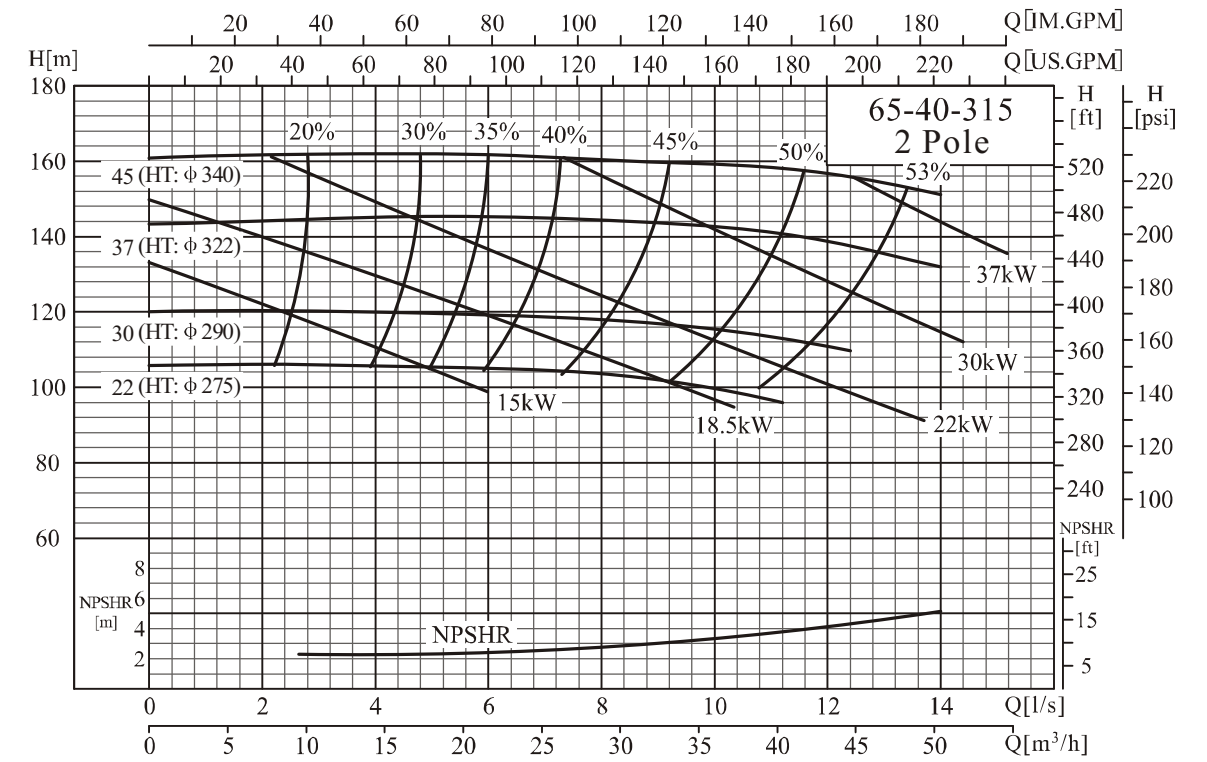

## ● NISO80-50-200/NISO80-50-250

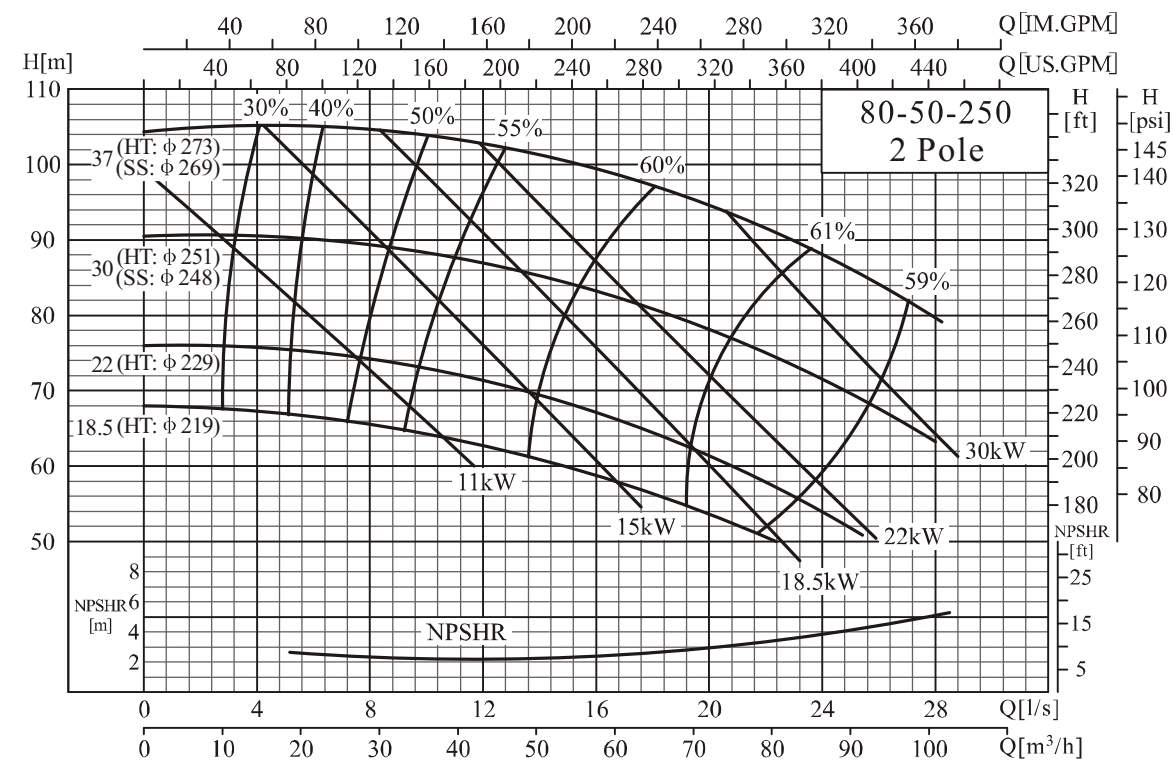
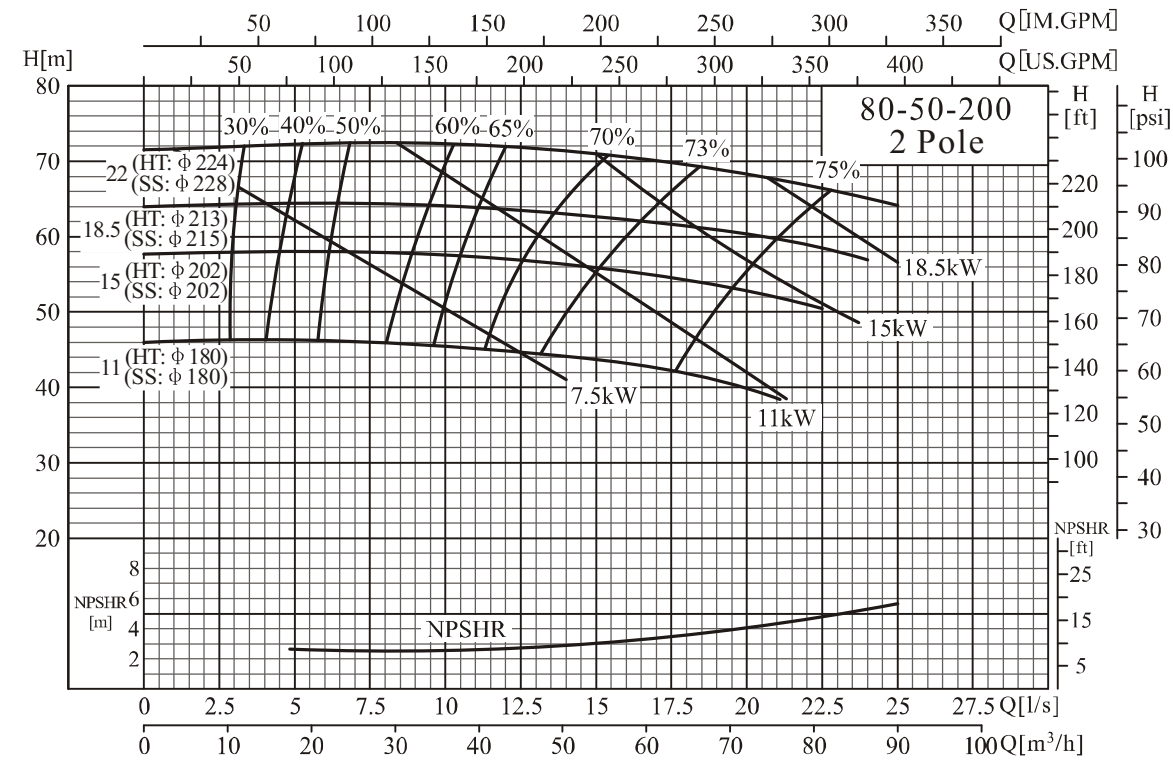

## ● NISO80-50-315/NISO80-65-160

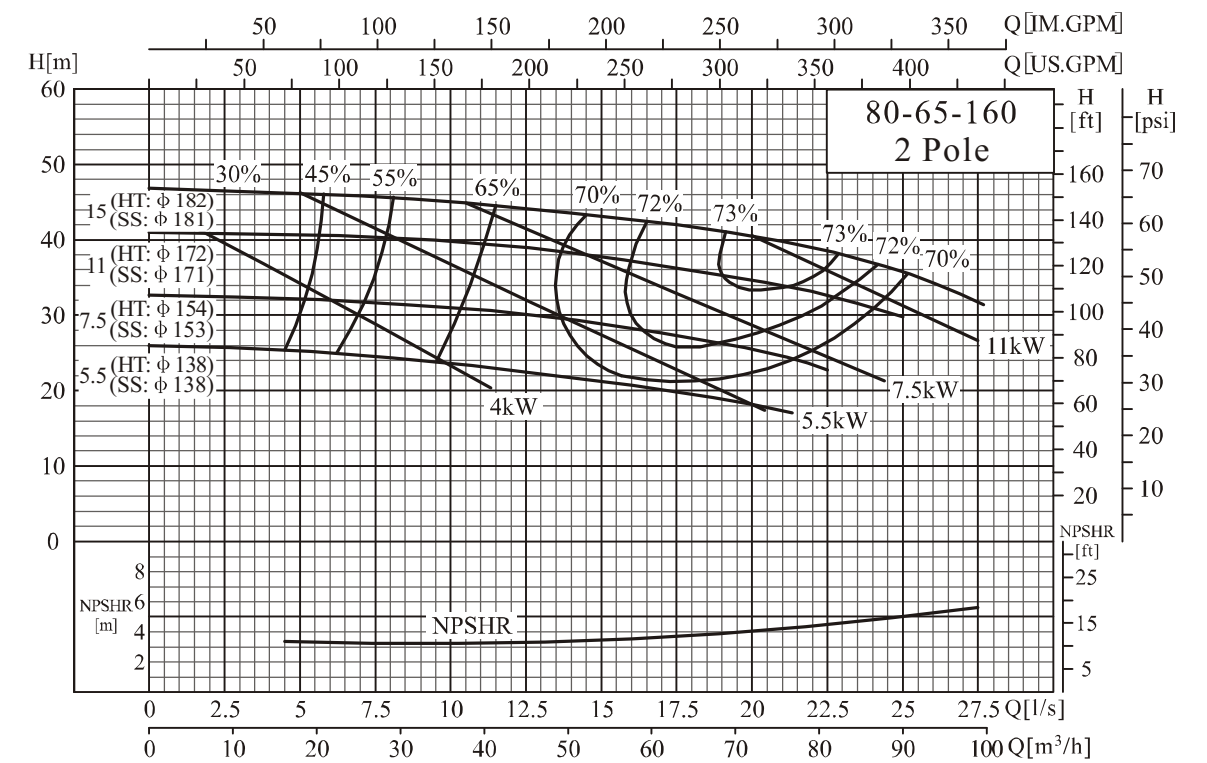
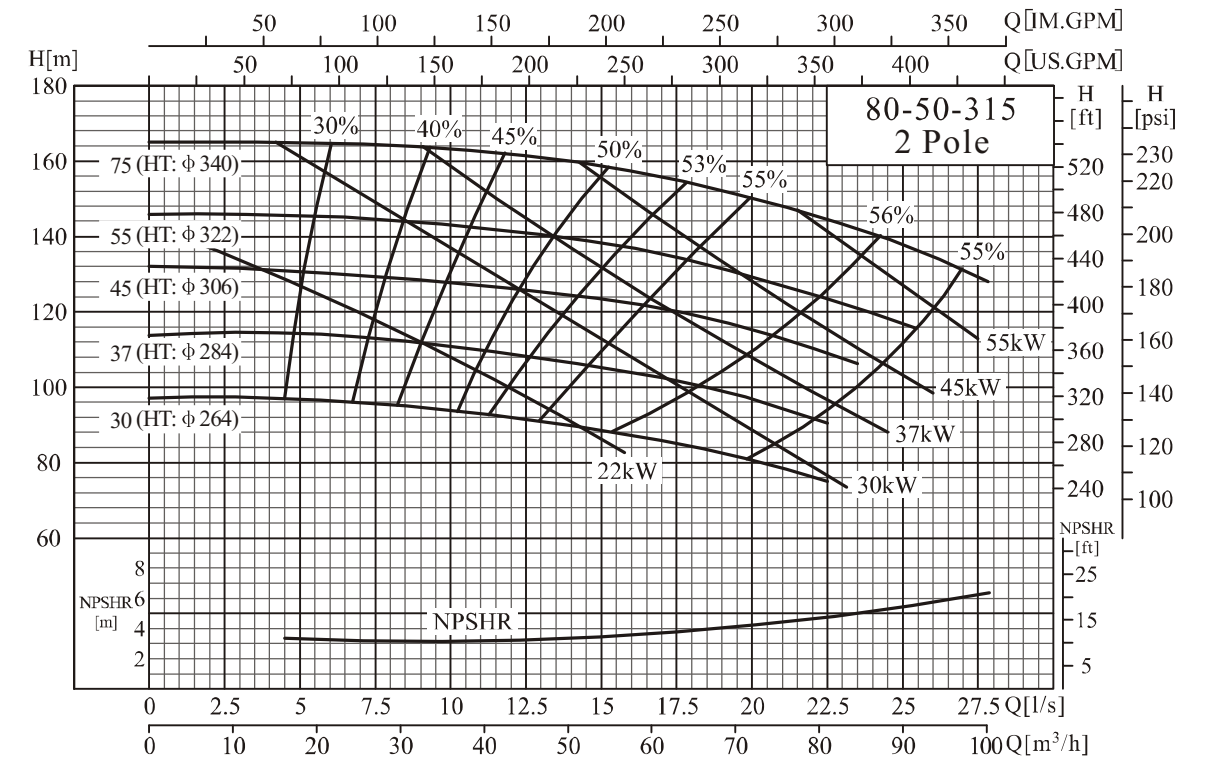



## ● NISO100-65-200/NISO100-65-250

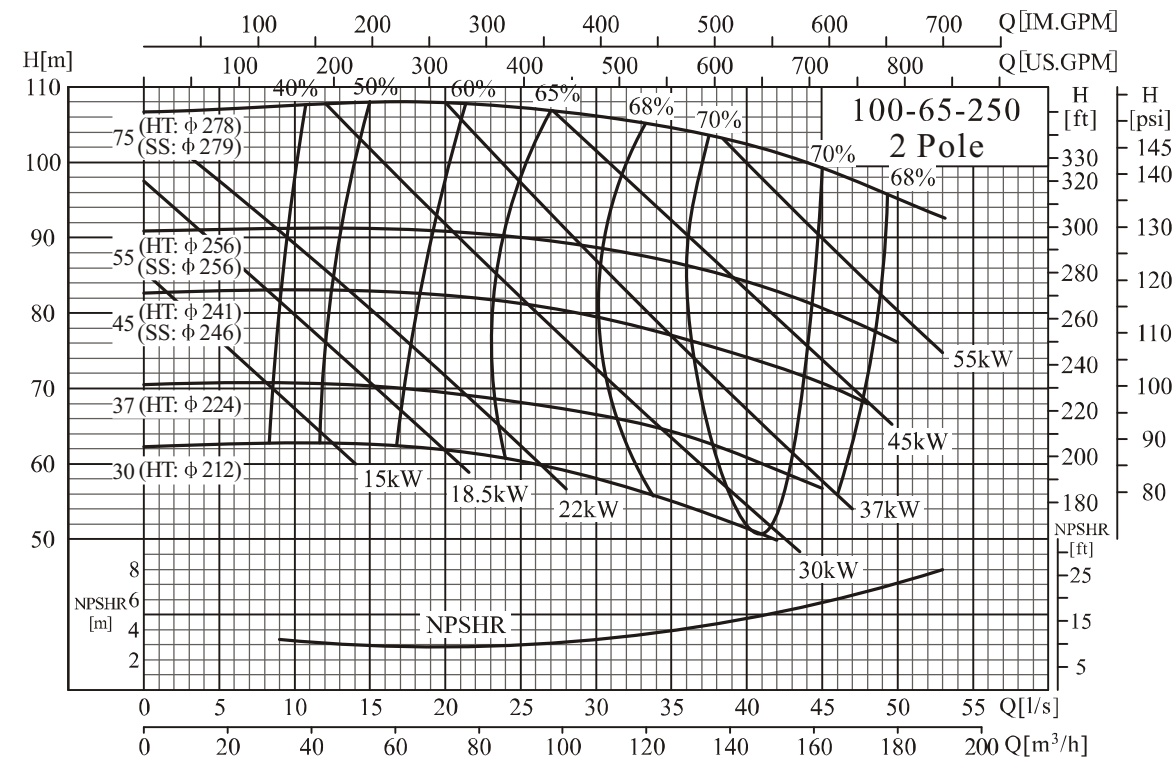
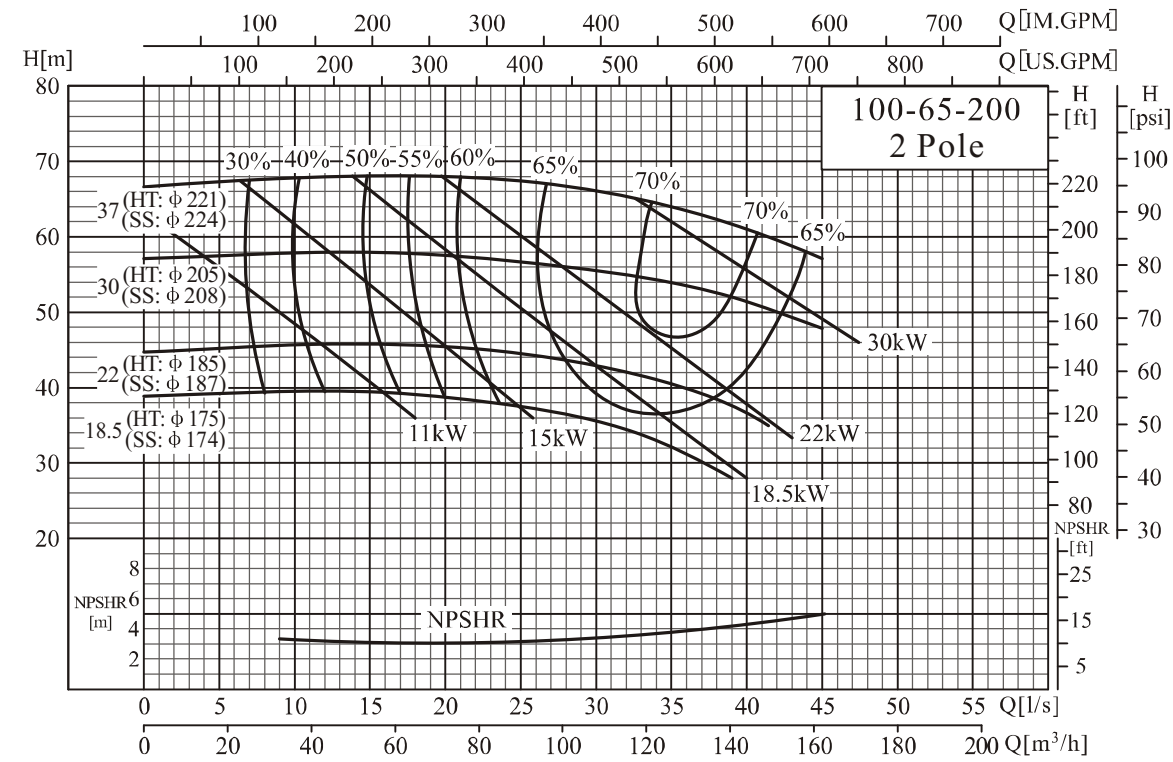

## ● NISO100-65-315/NISO100-80-160

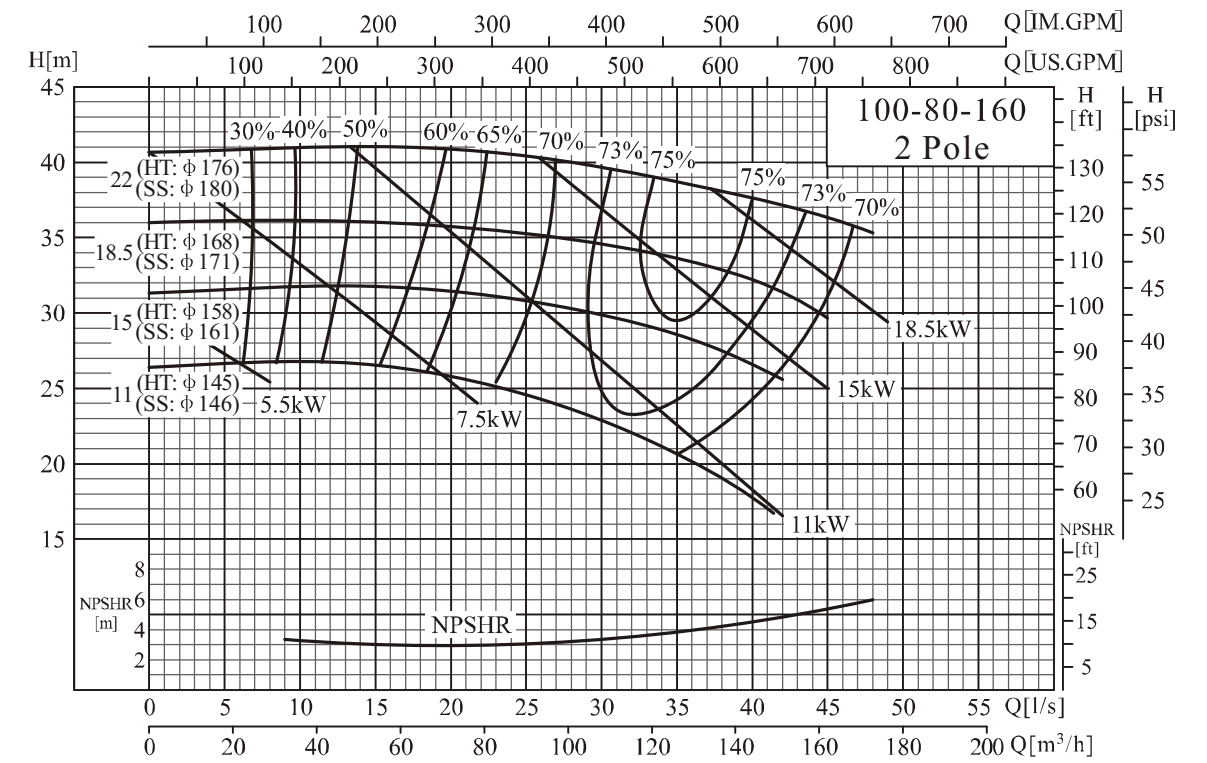
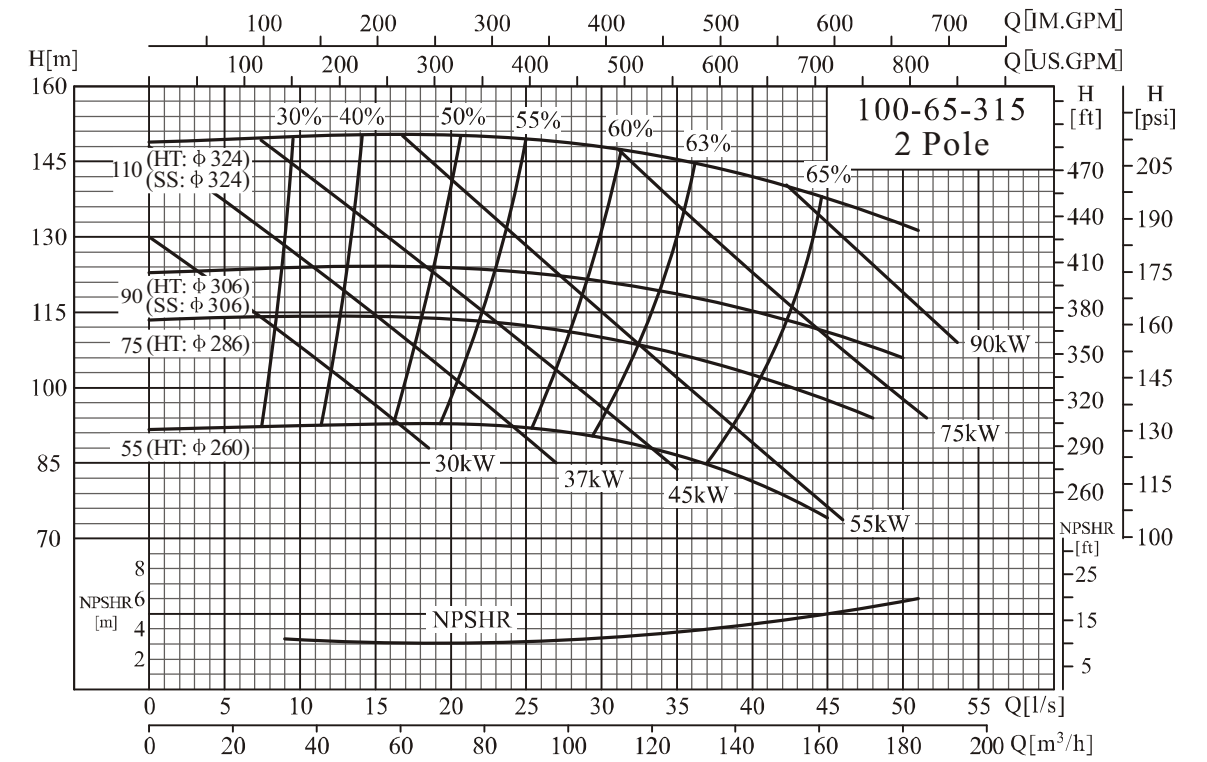

● NISO125-100-200/NISO125-100-250

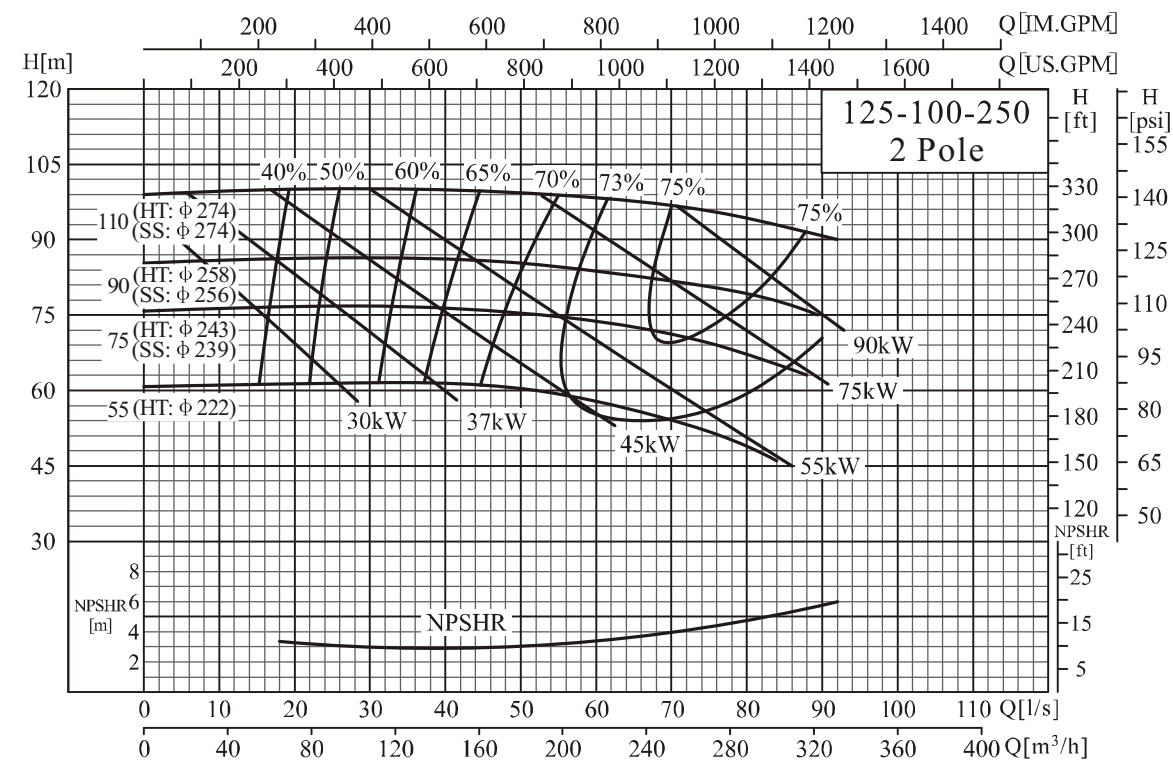
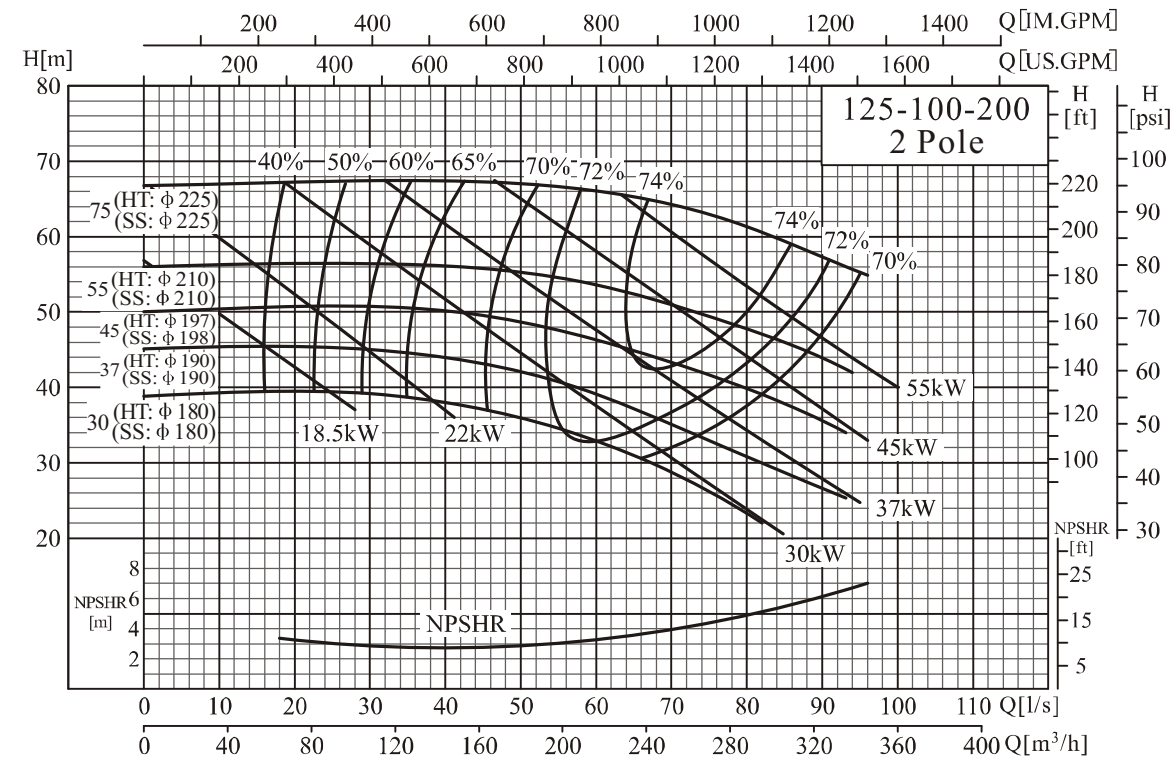

● NISO125-100-315/NISO50-32-160

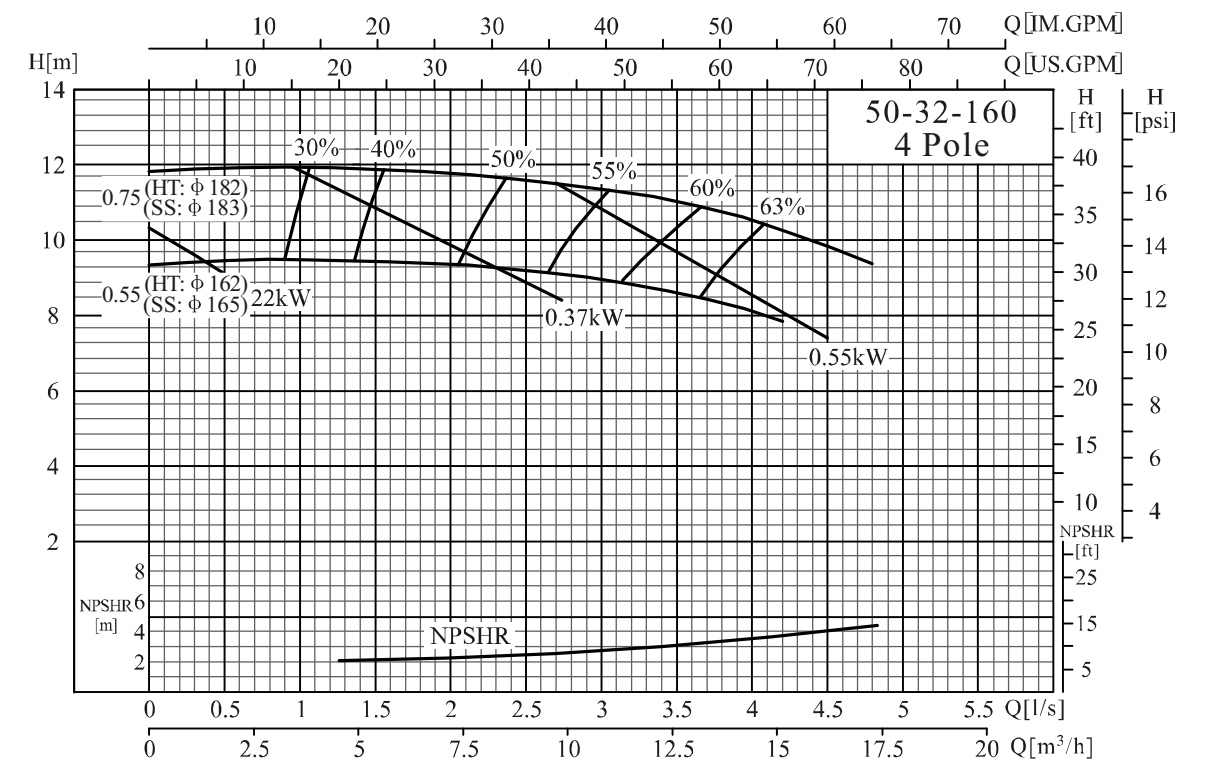
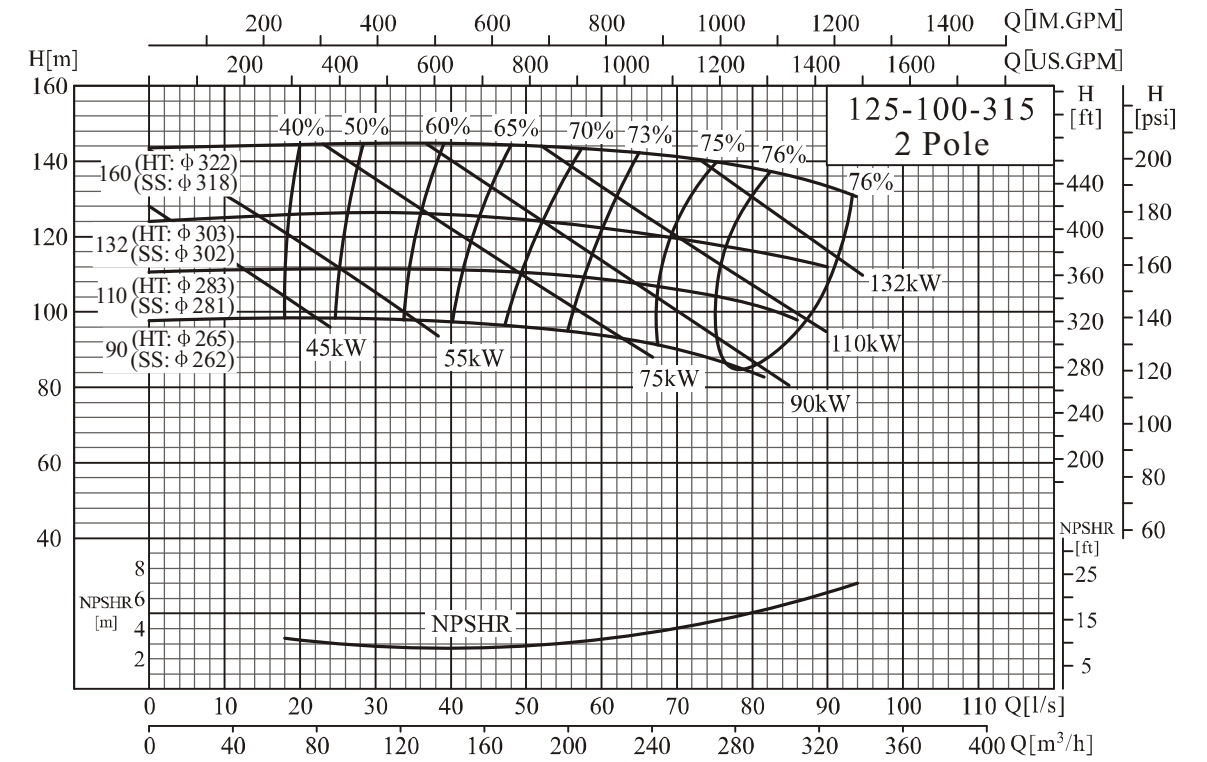

## ● NISO50-32-200/NISO65-40-200

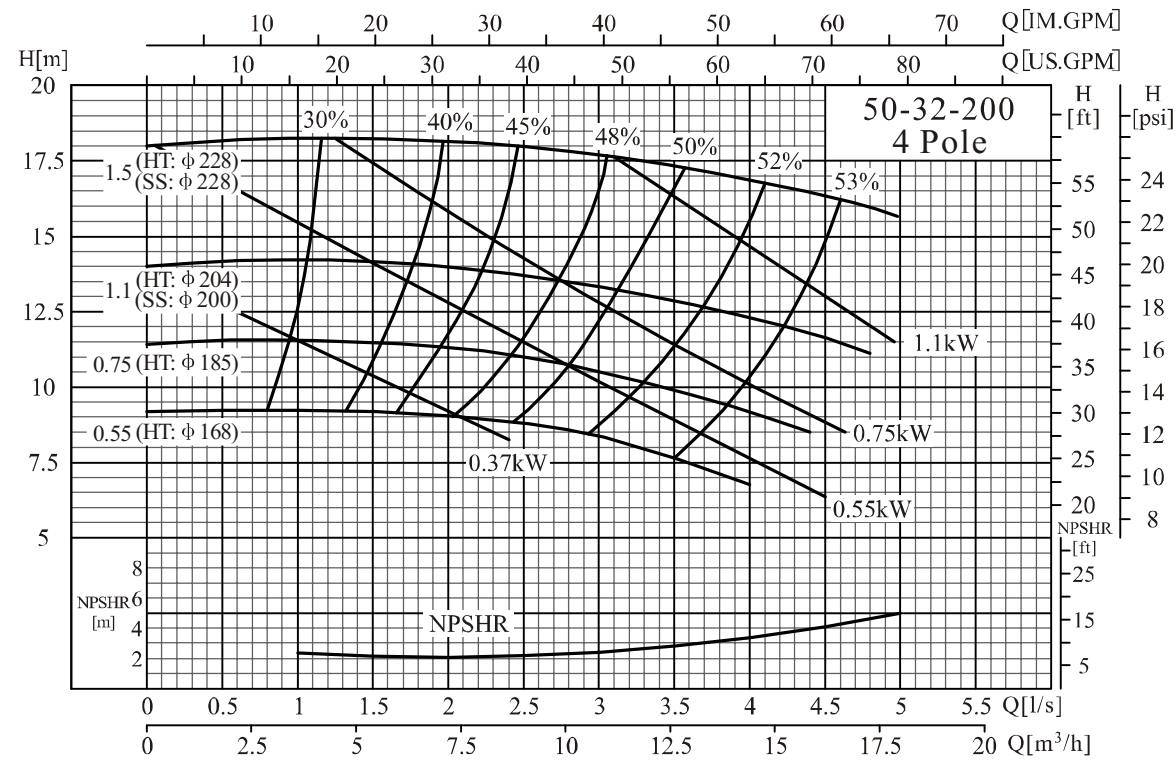

## ● NISO65-40-250/NISO65-40-315

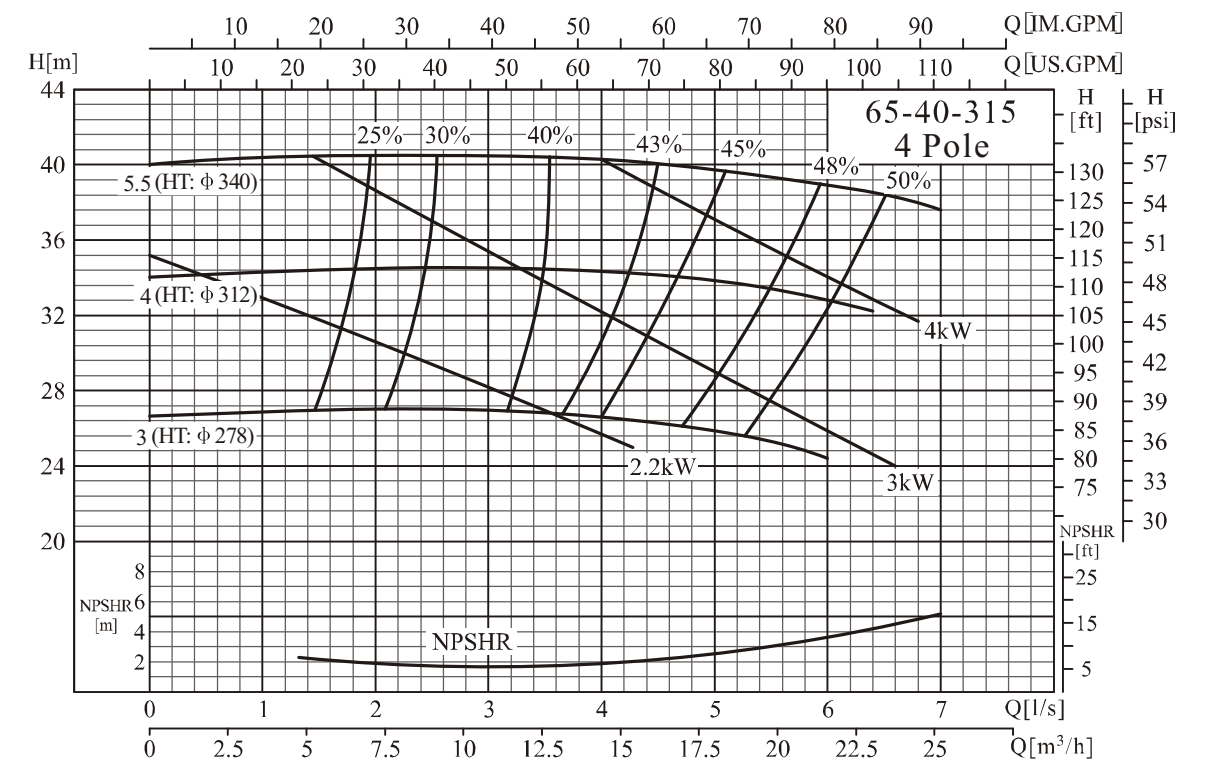
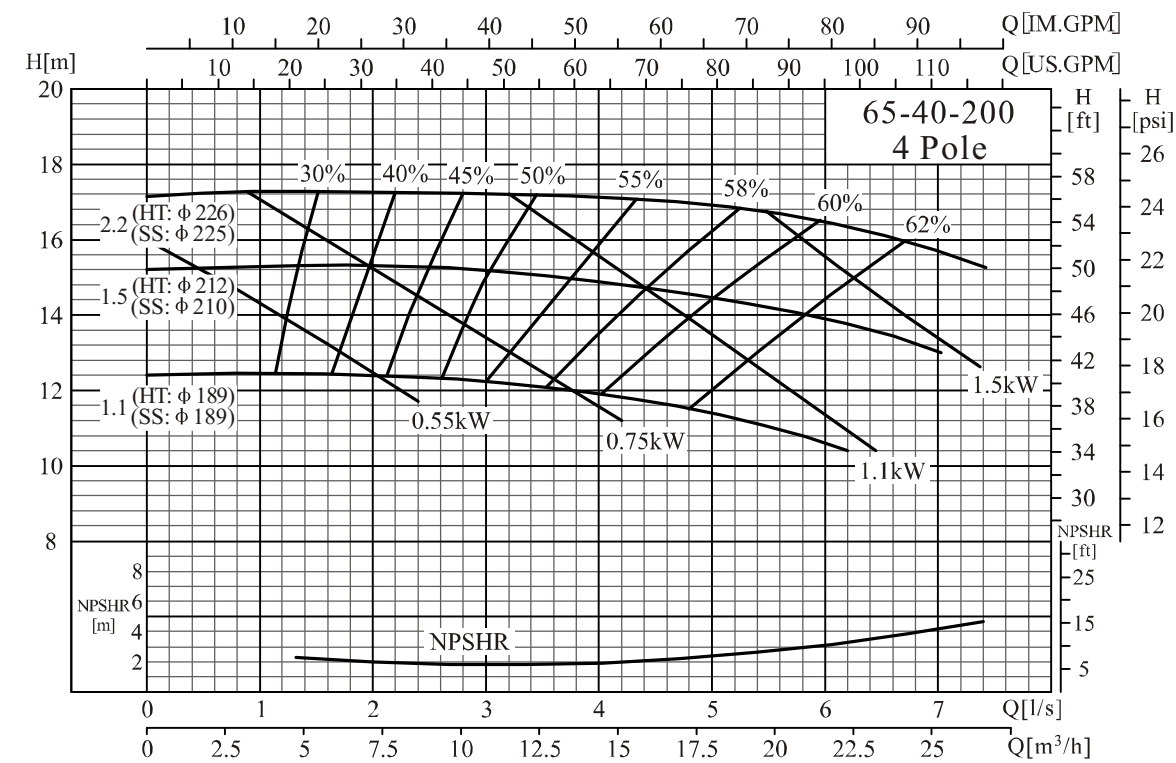
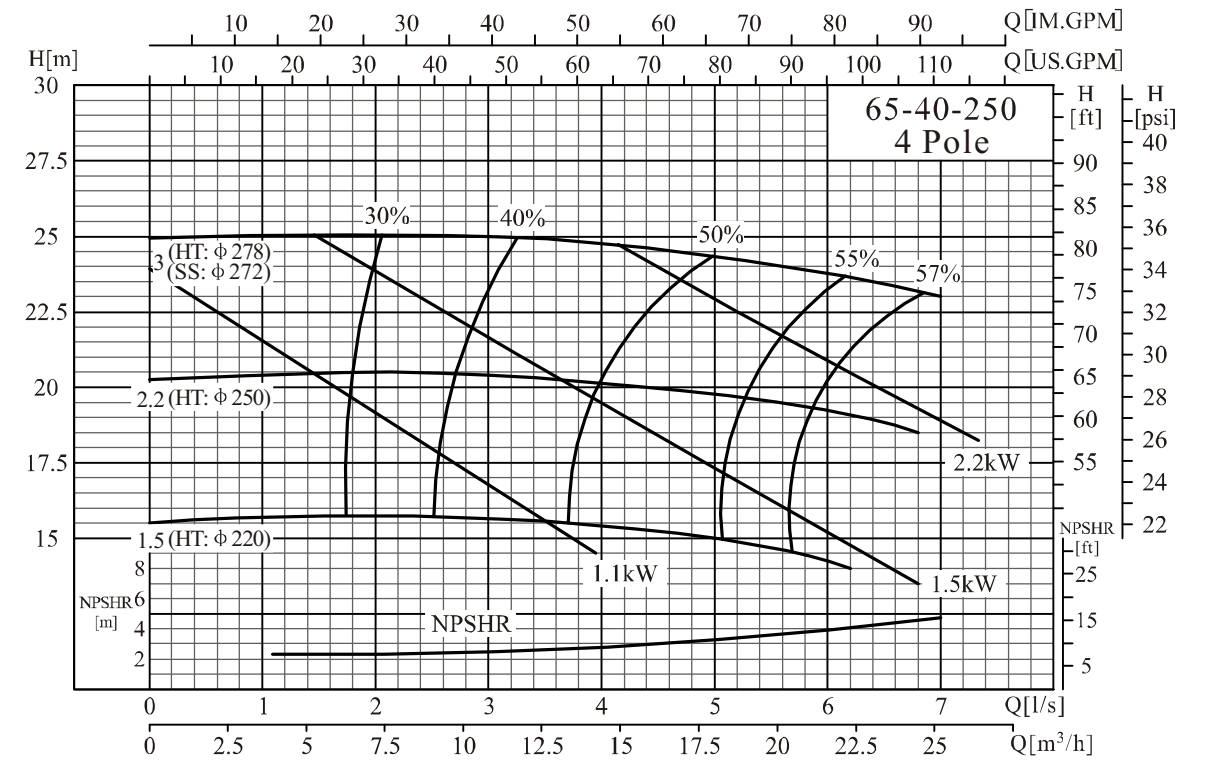

## ● NISO65-50-160/NISO80-50-200

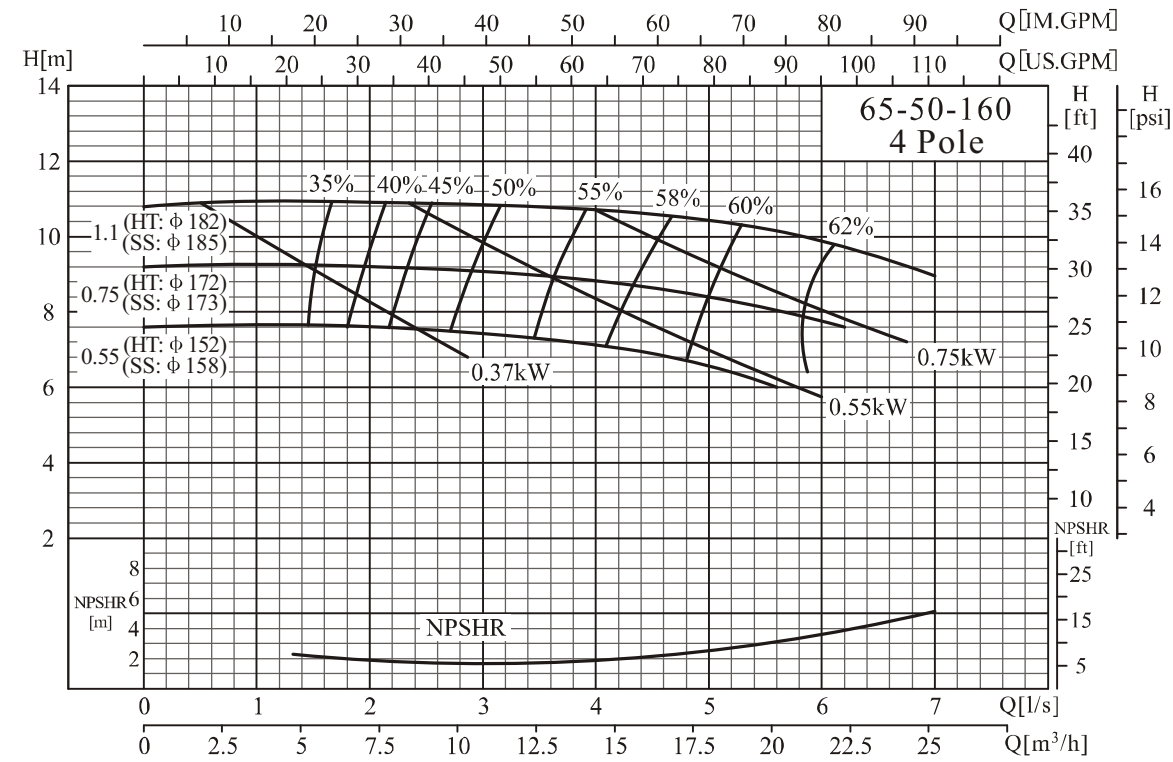

## ● NISO80-50-250/NISO80-50-315

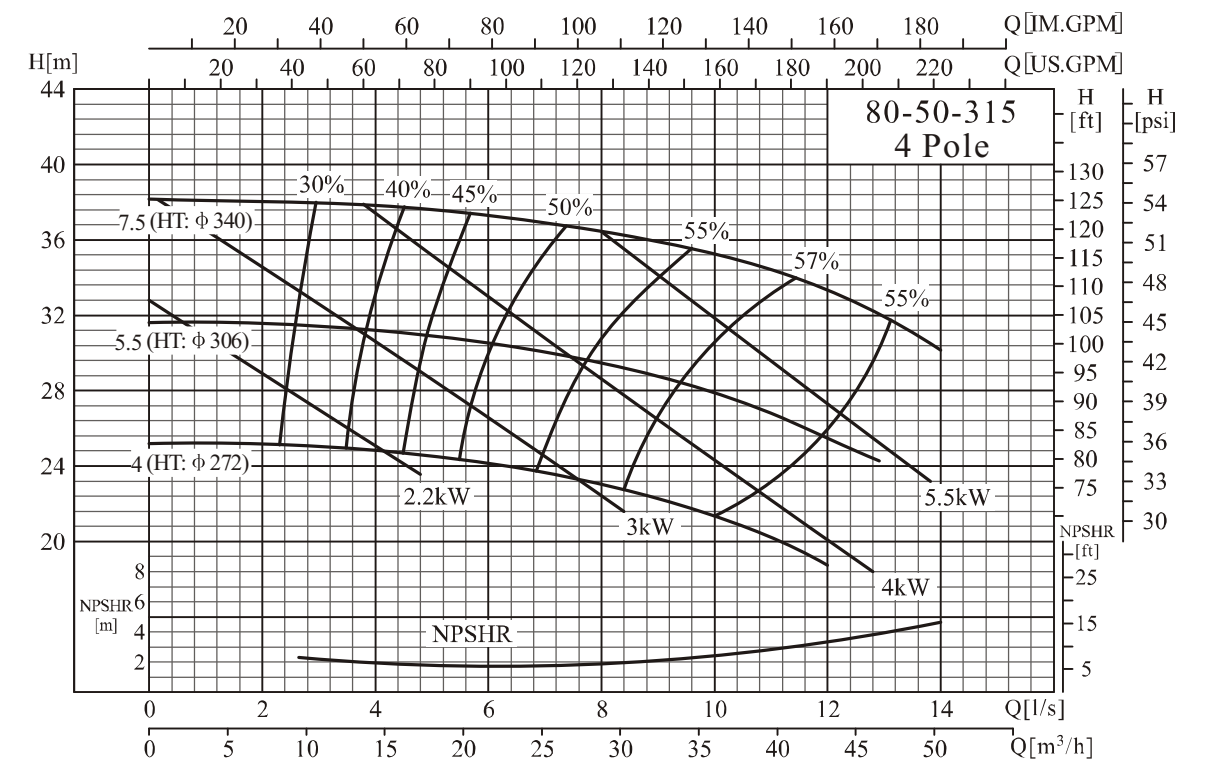
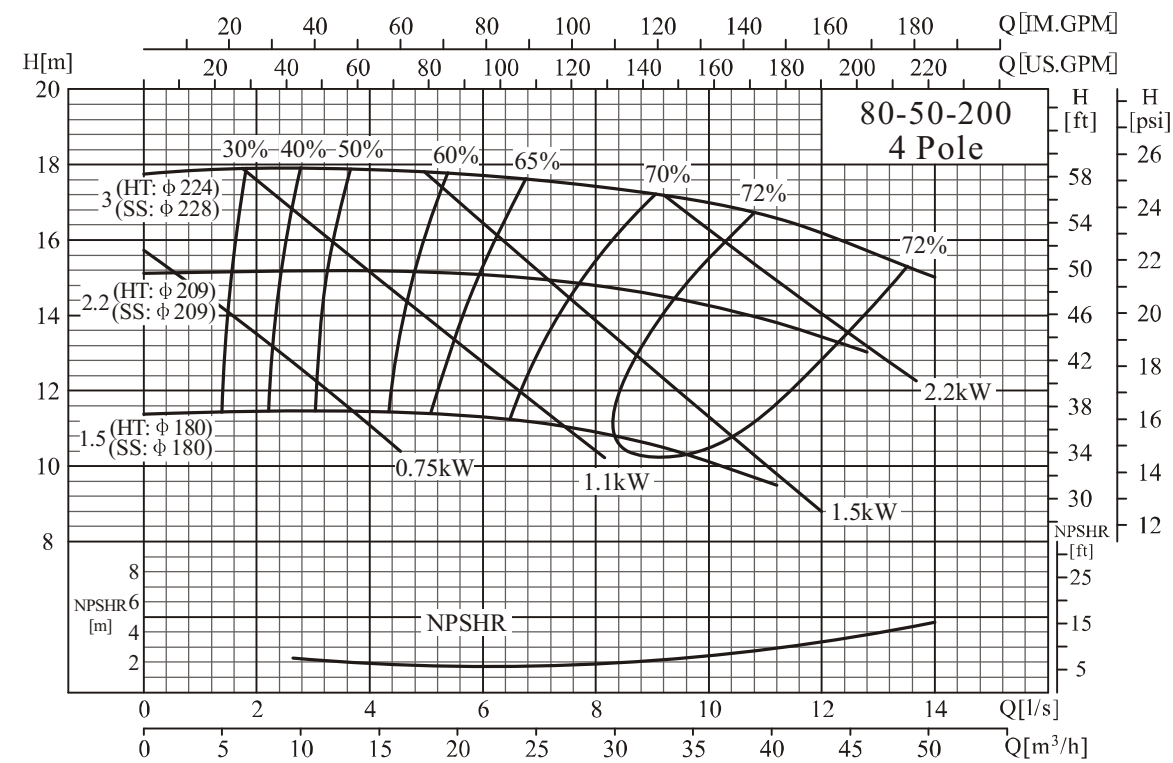
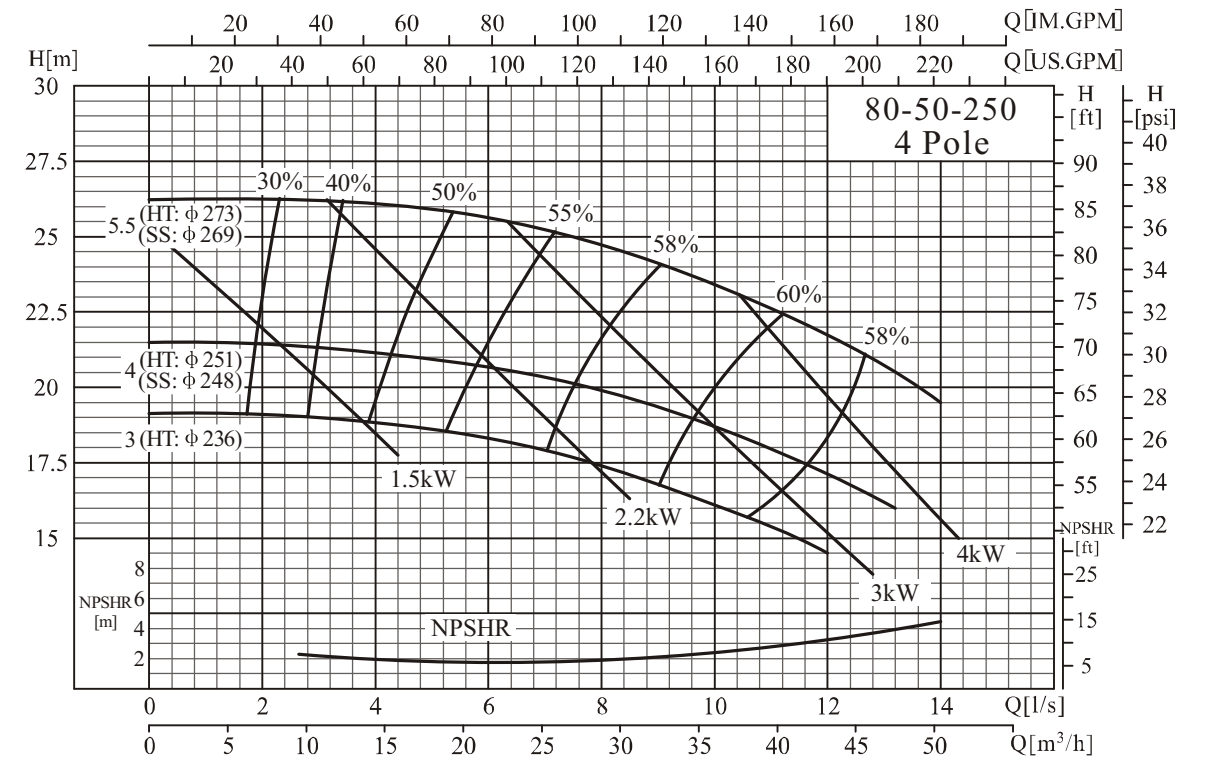

## ● NISO80-65-160/NISO100-65-200

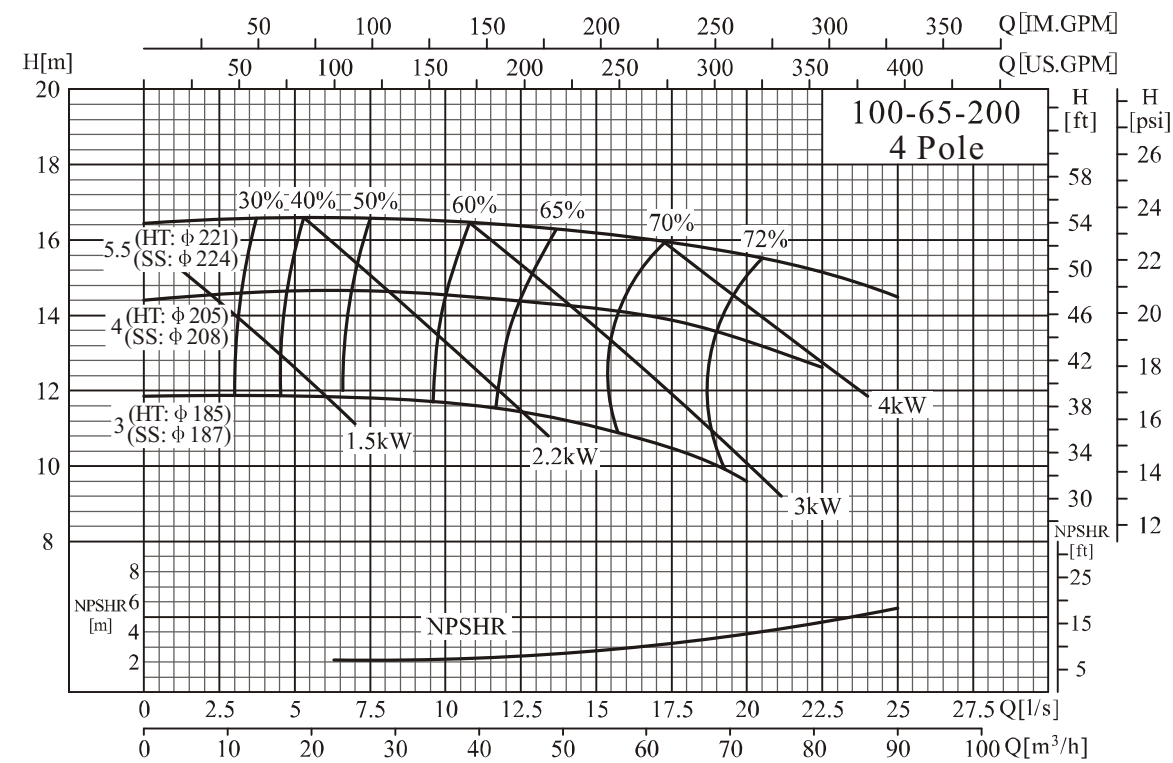
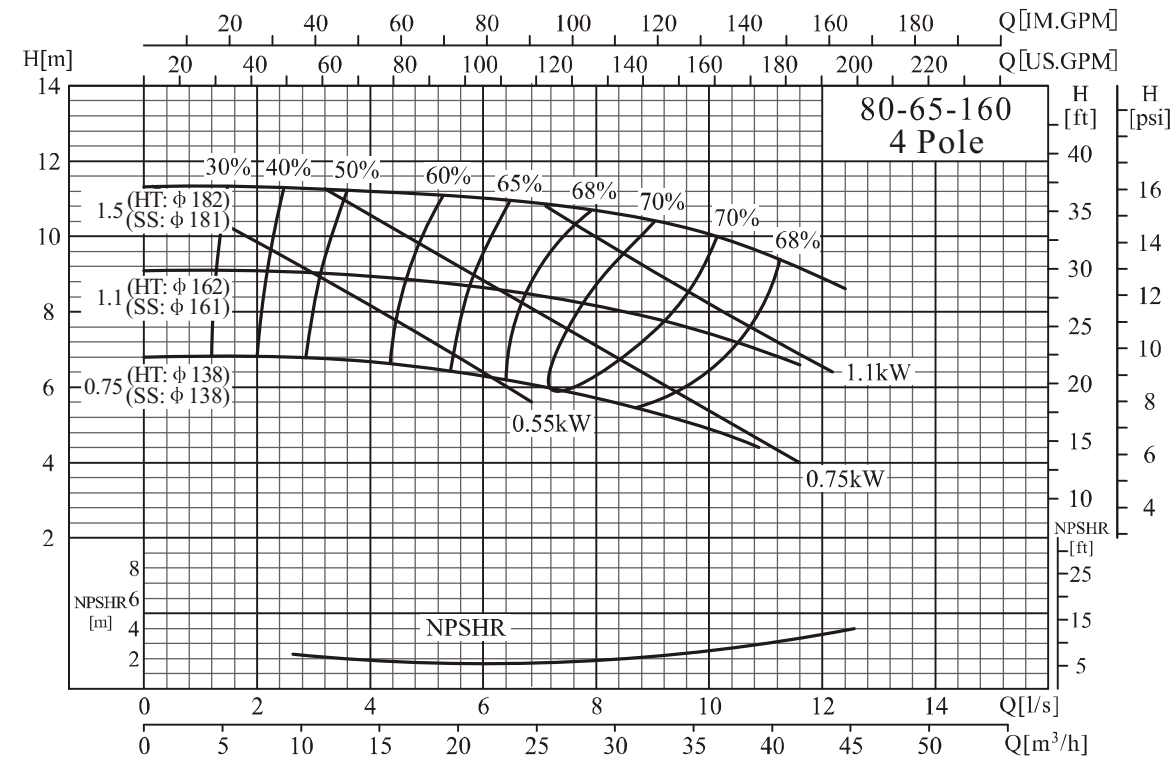

## ● NISO100-65-250/NISO100-65-315

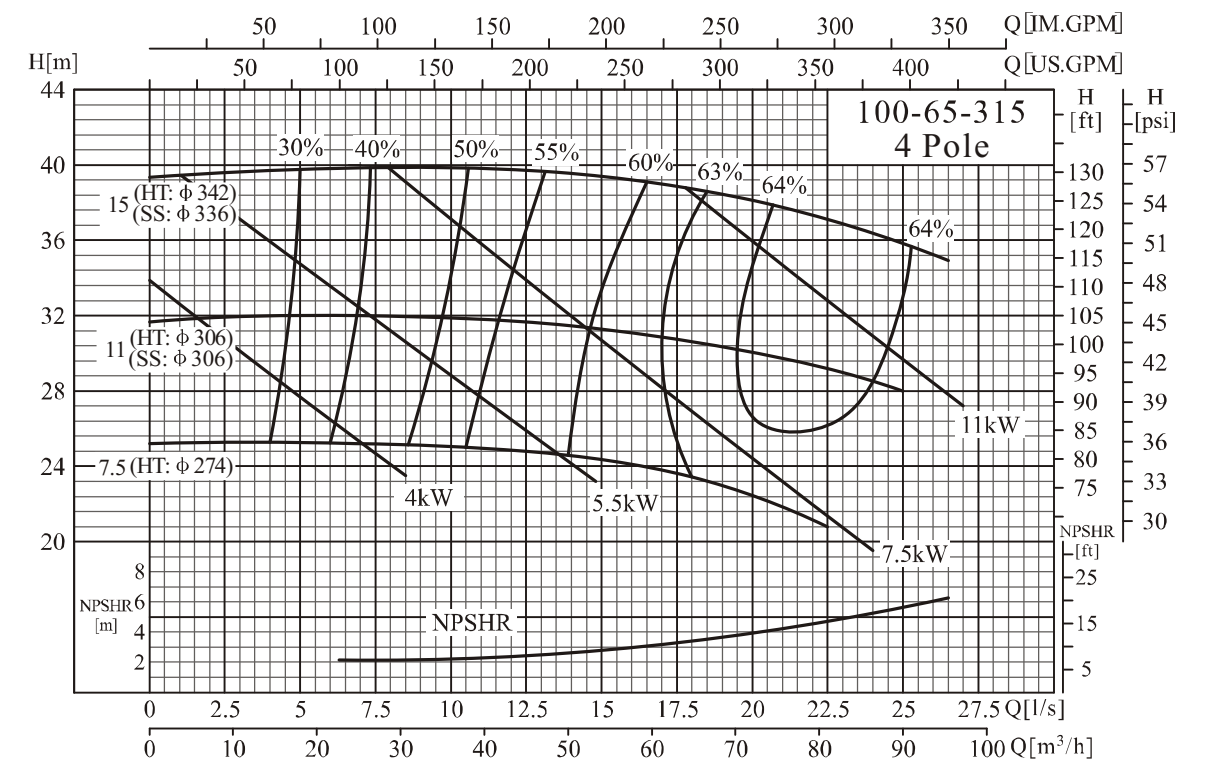
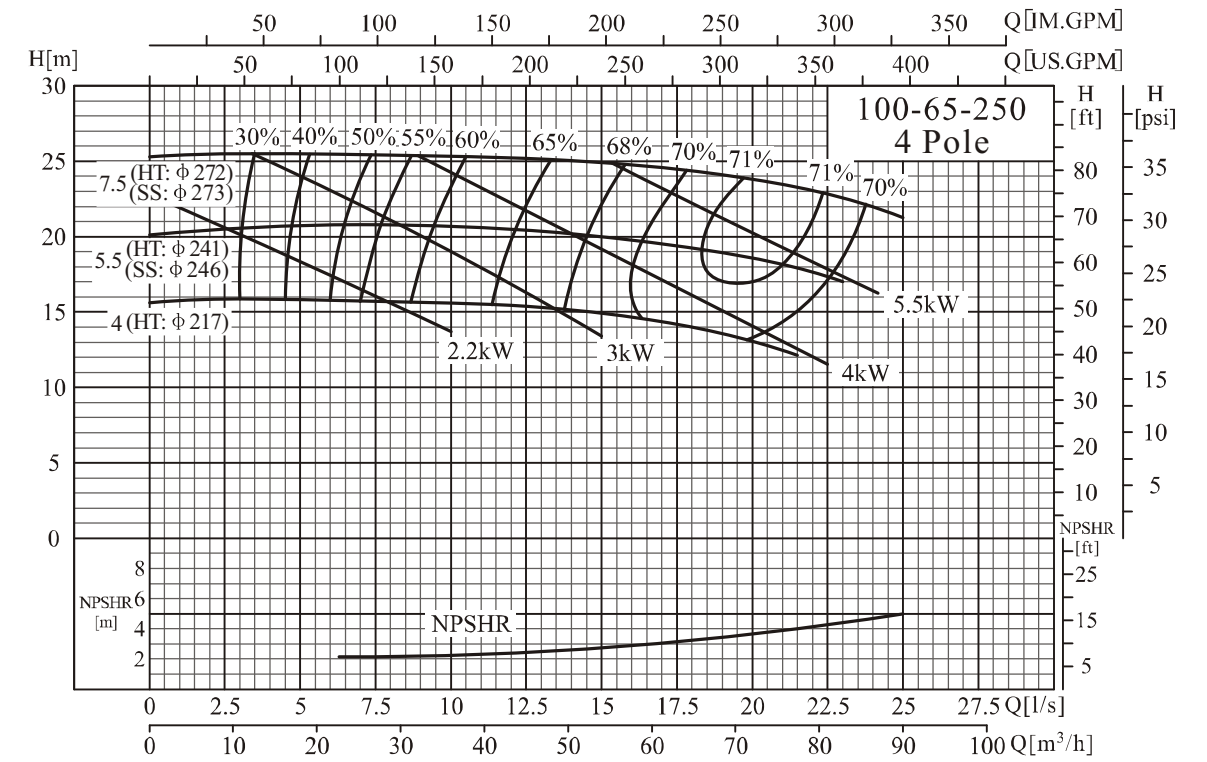

## ● NISO100-80-160/NISO125-100-200

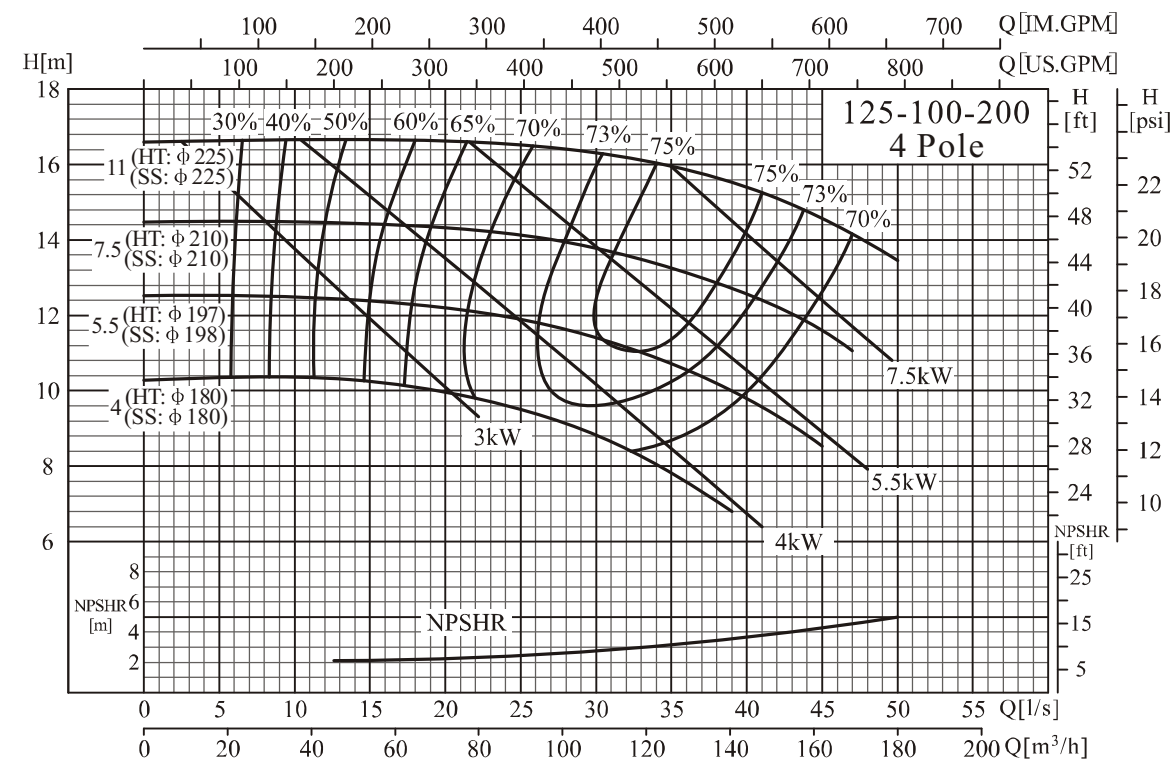
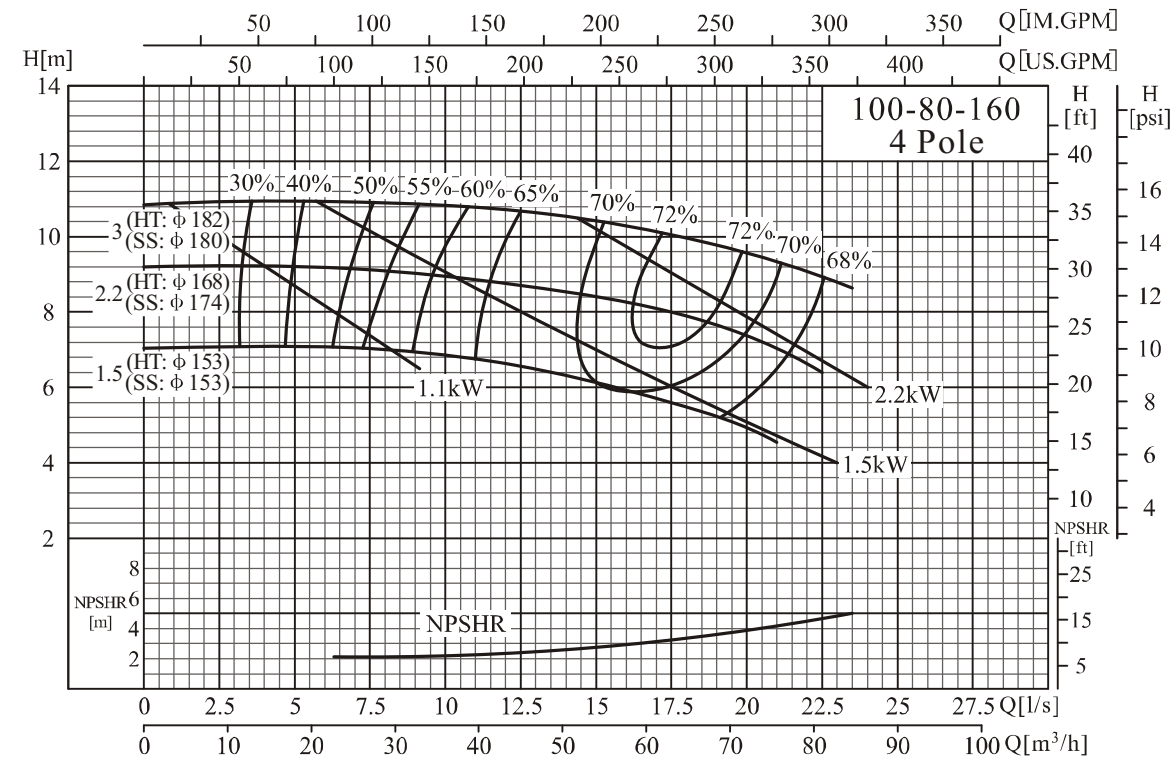

## ● NISO125-100-250/NISO125-100-315

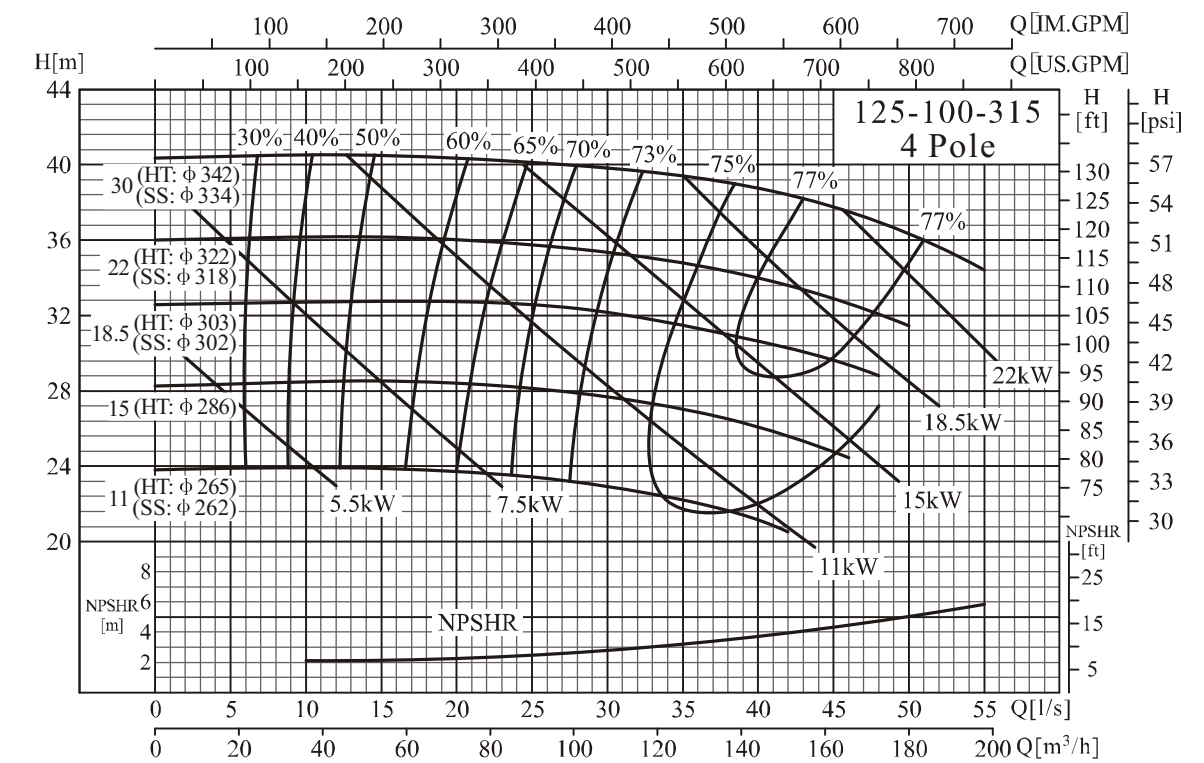
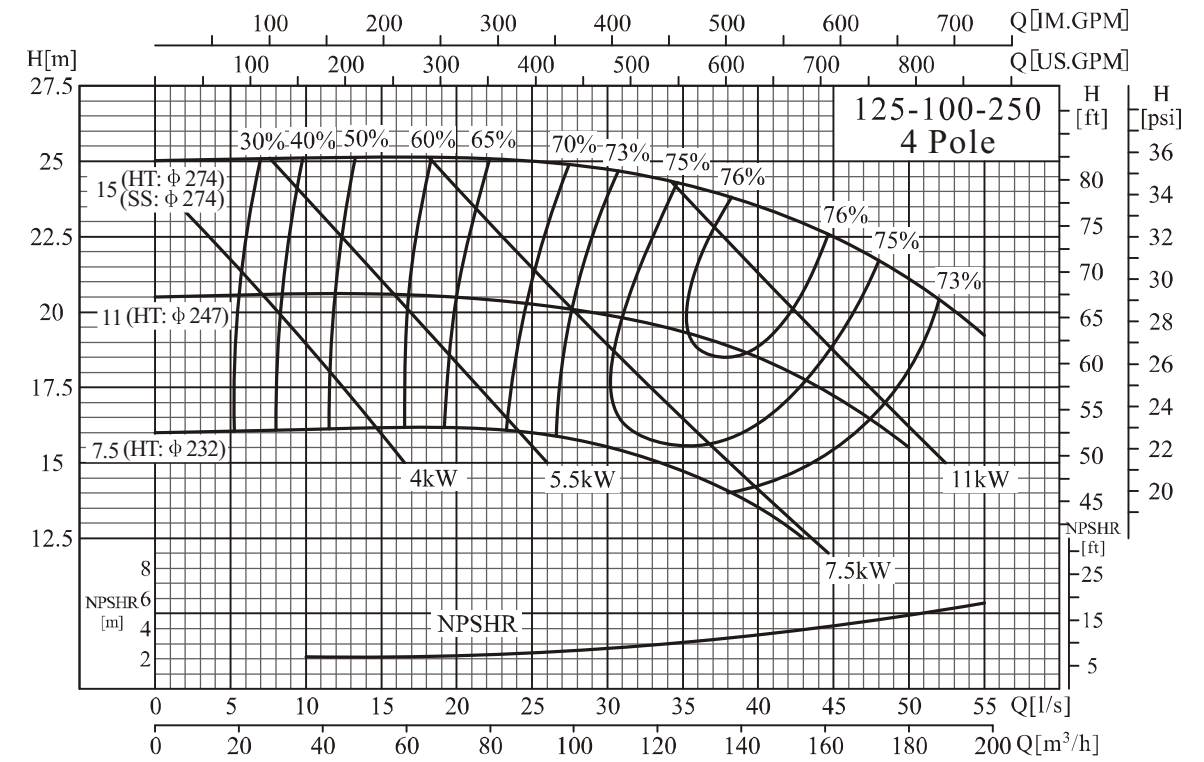

## ● NISO125-80-400/NISO125-100-400

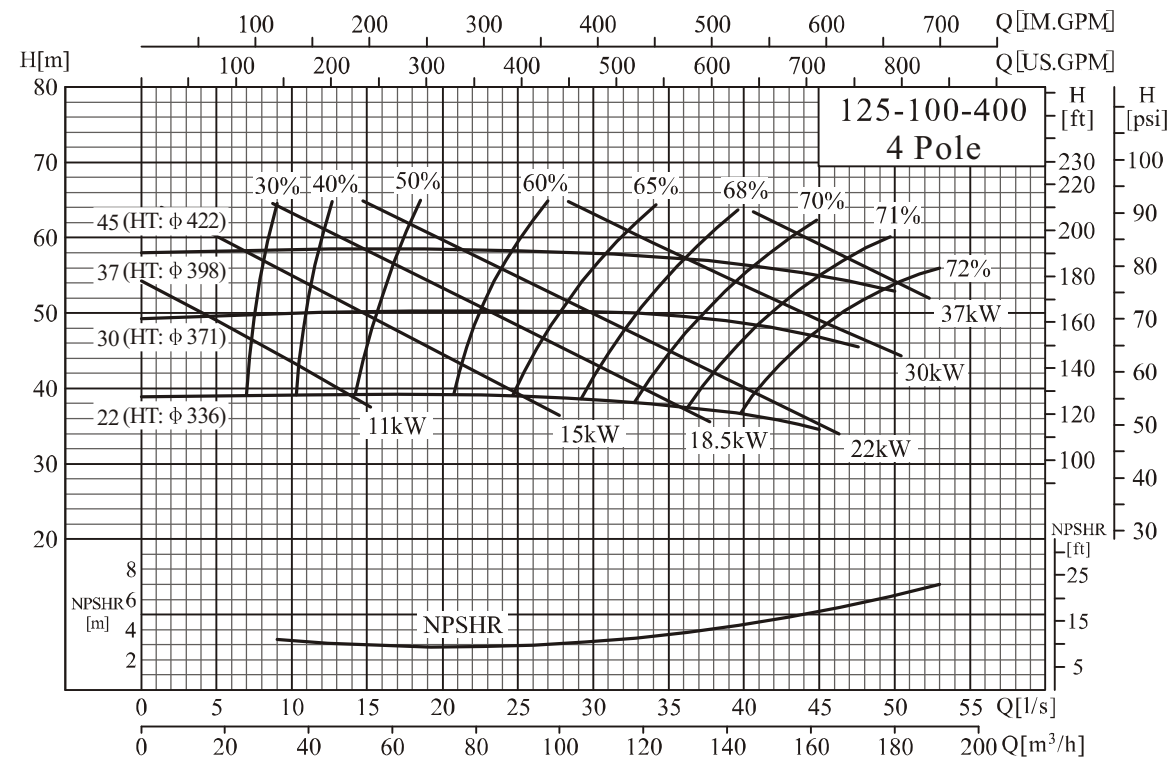
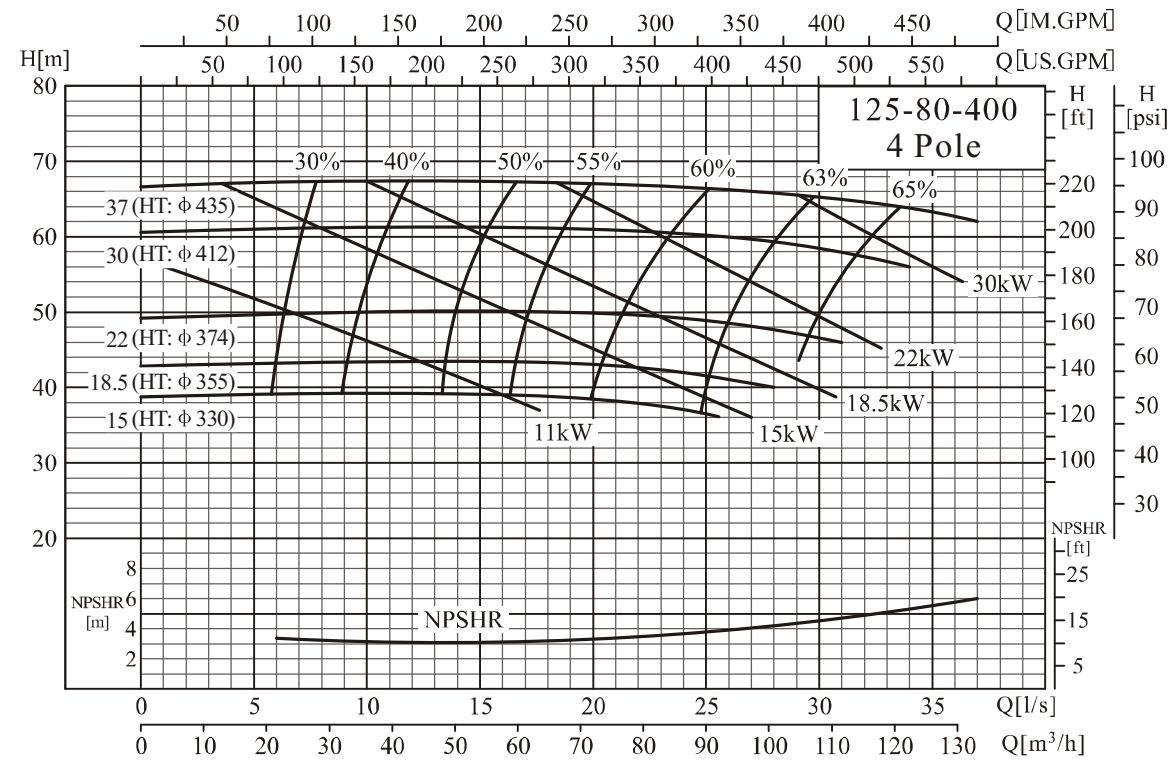

## ● NISO150-125-250/NISO150-125-315

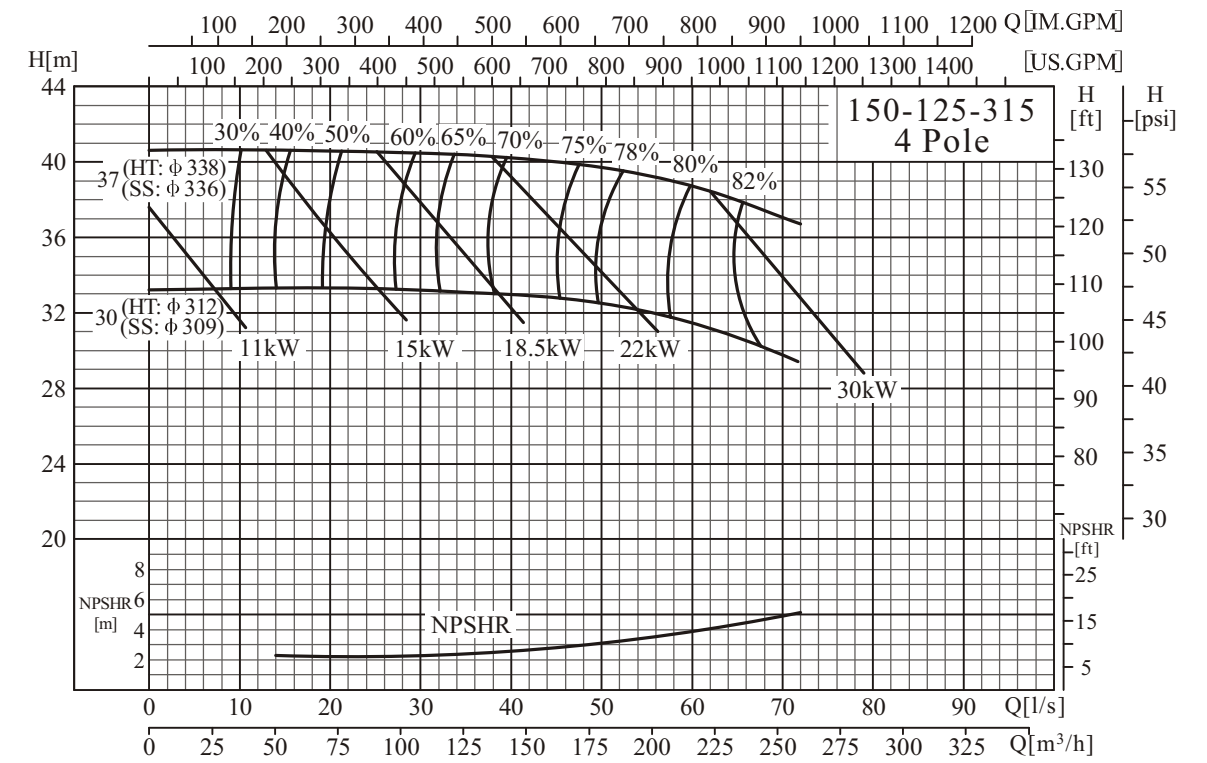
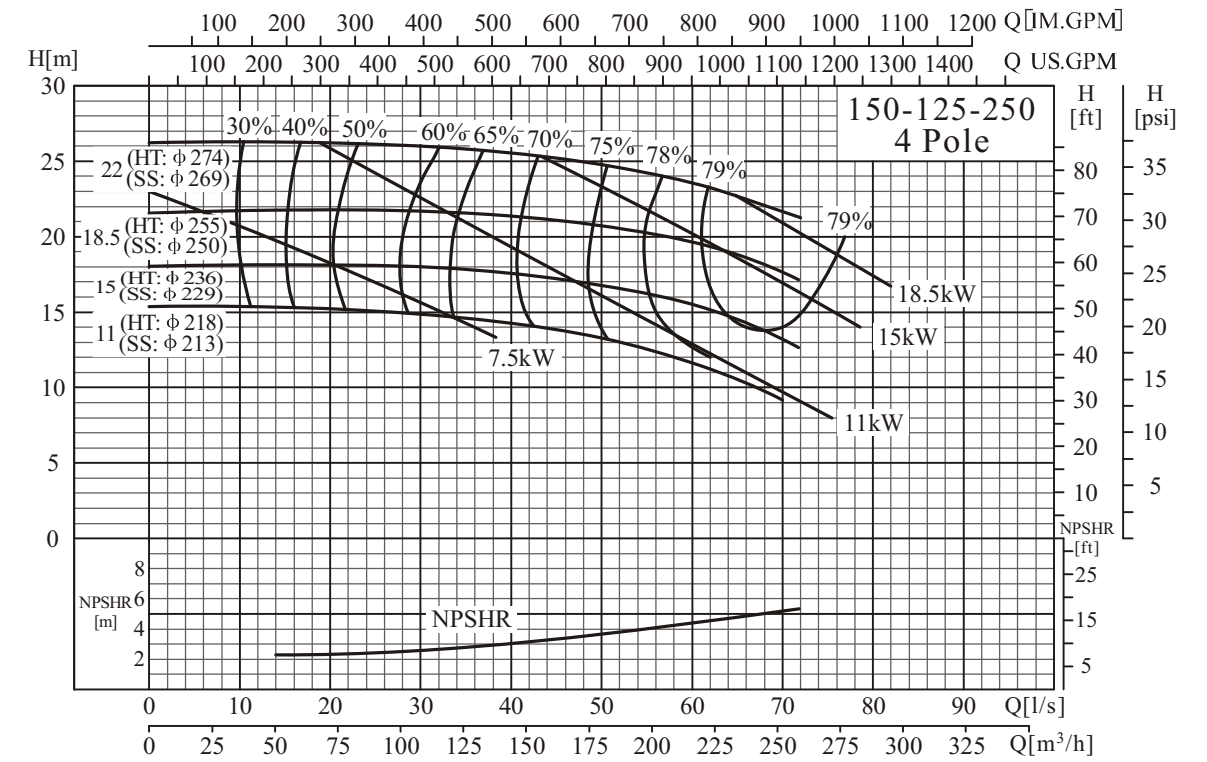

## ● NISO150-125-400/NISO200-150-315

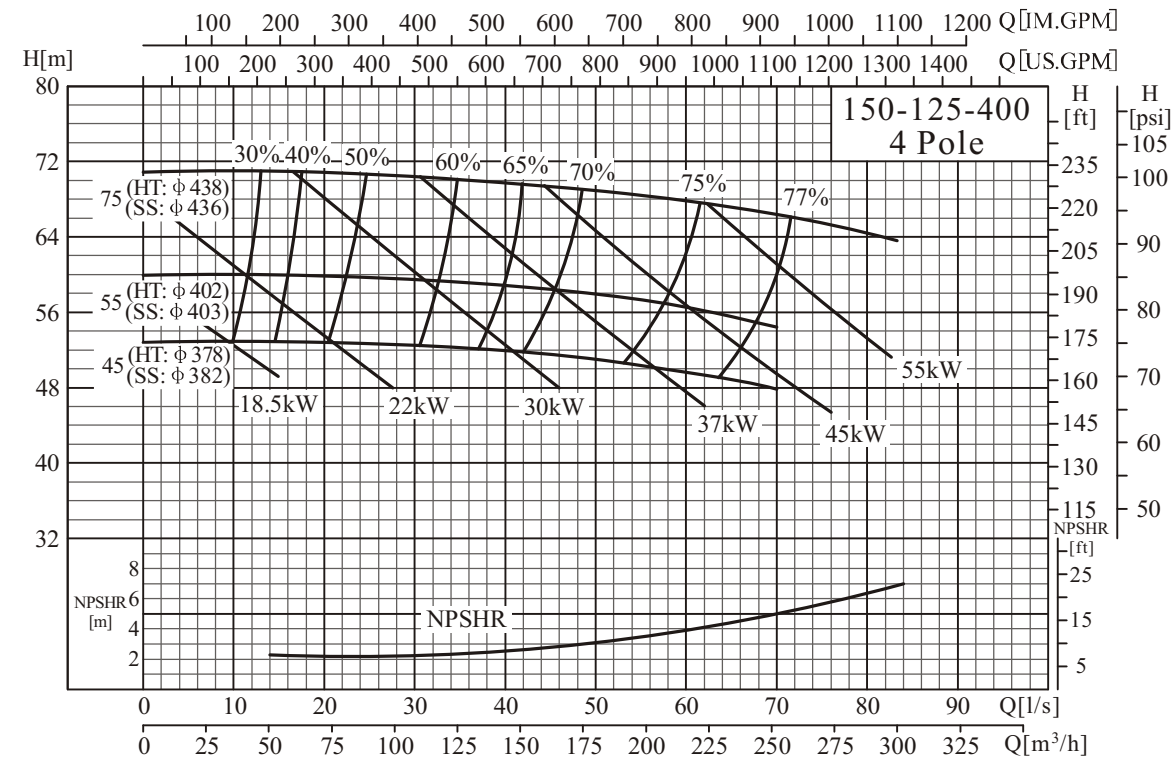

## ● NISO200-150-400/NISO250-200-315

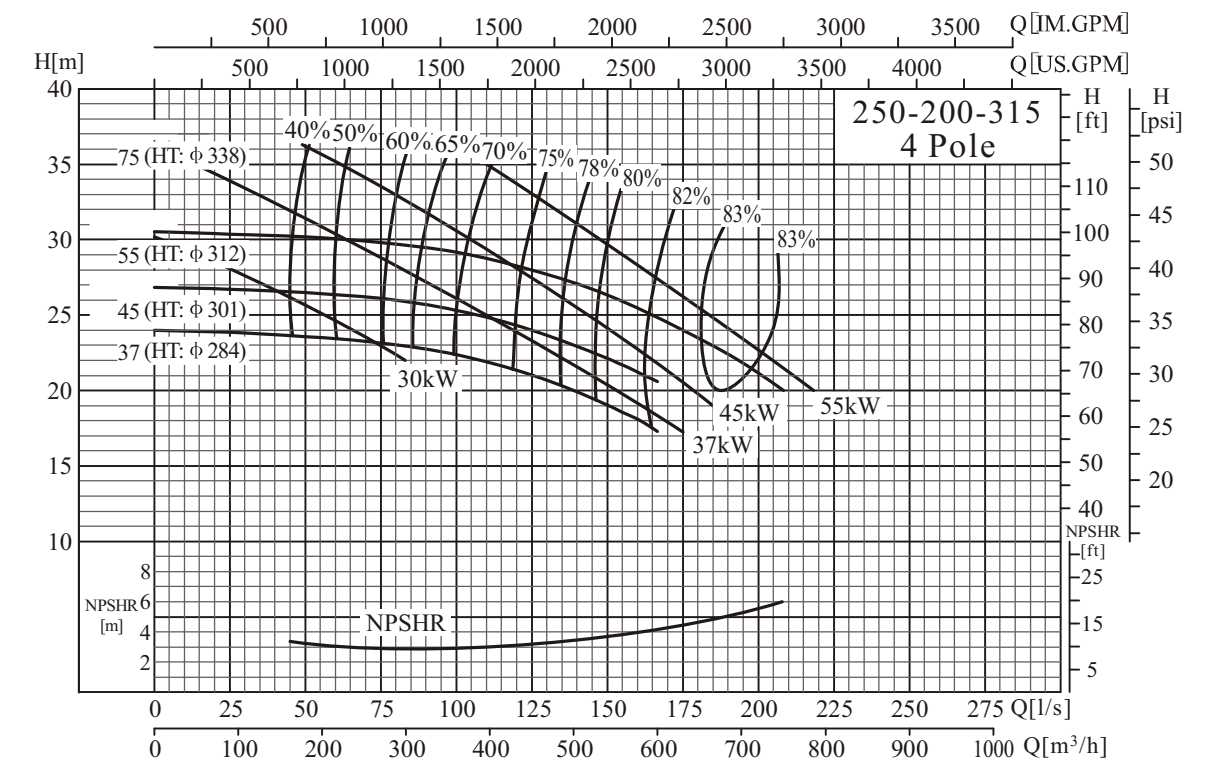
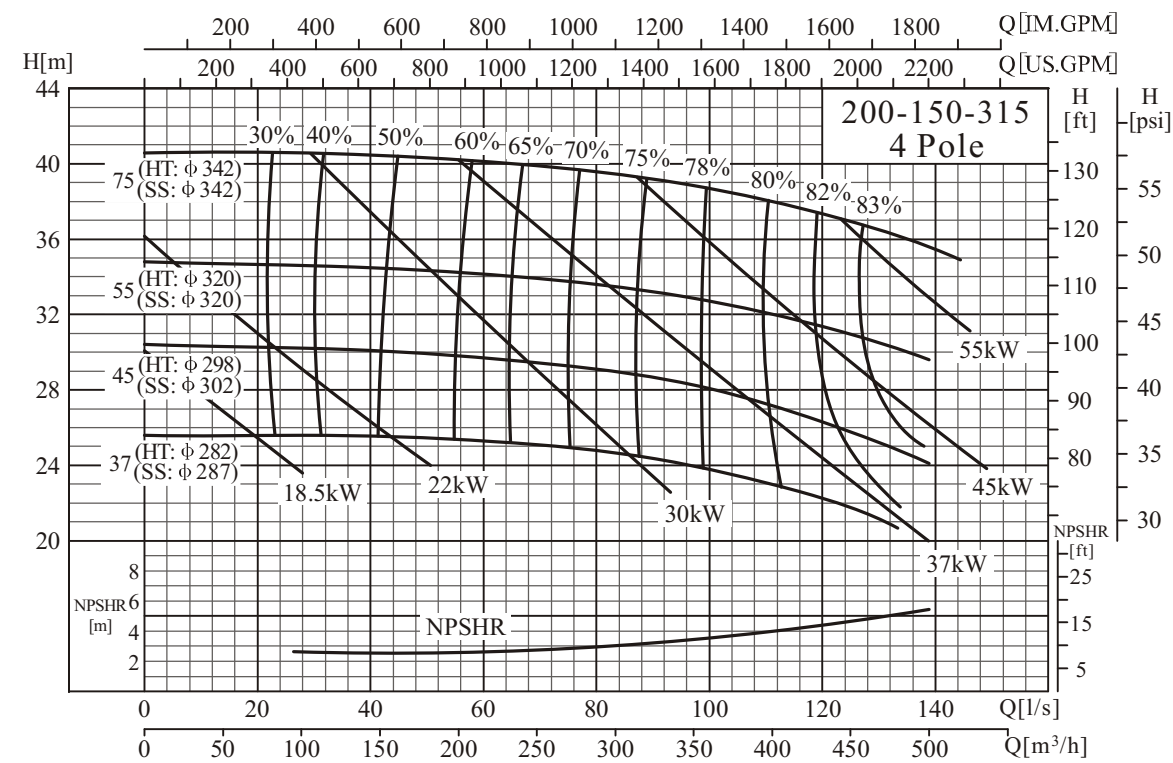
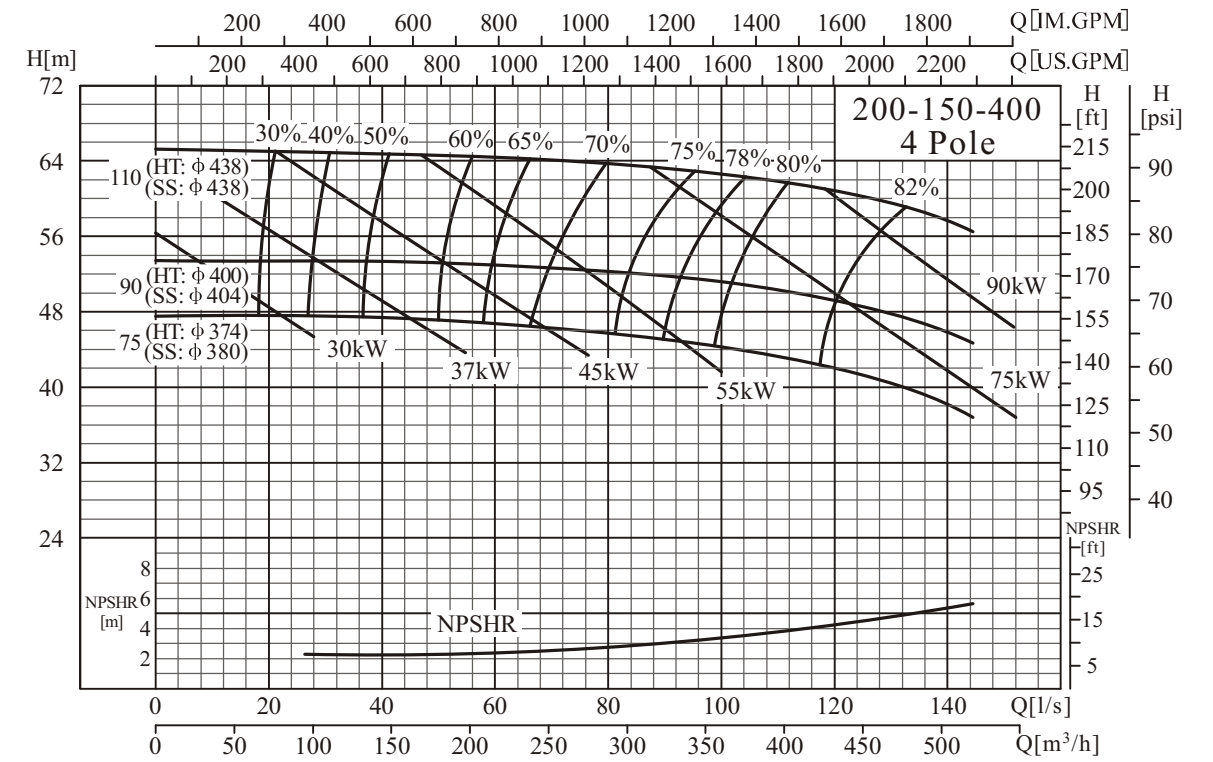



## ● NISO250-200-400

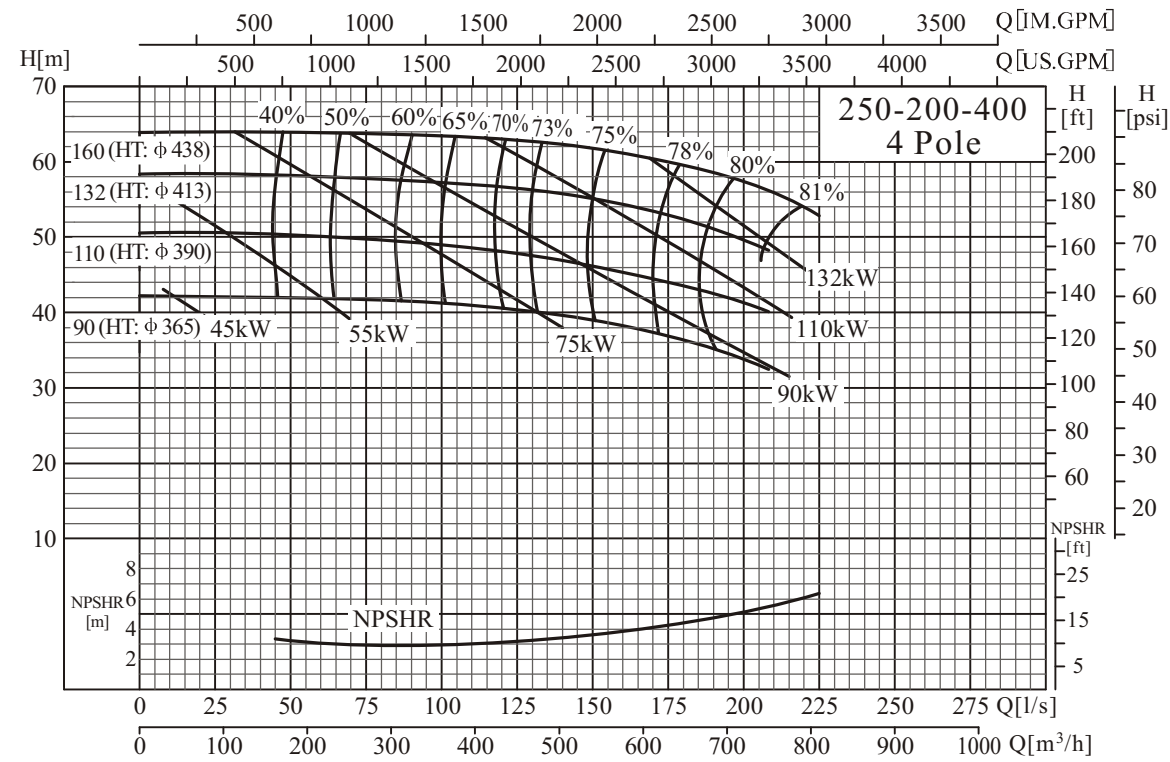

## ● Pump dimensions

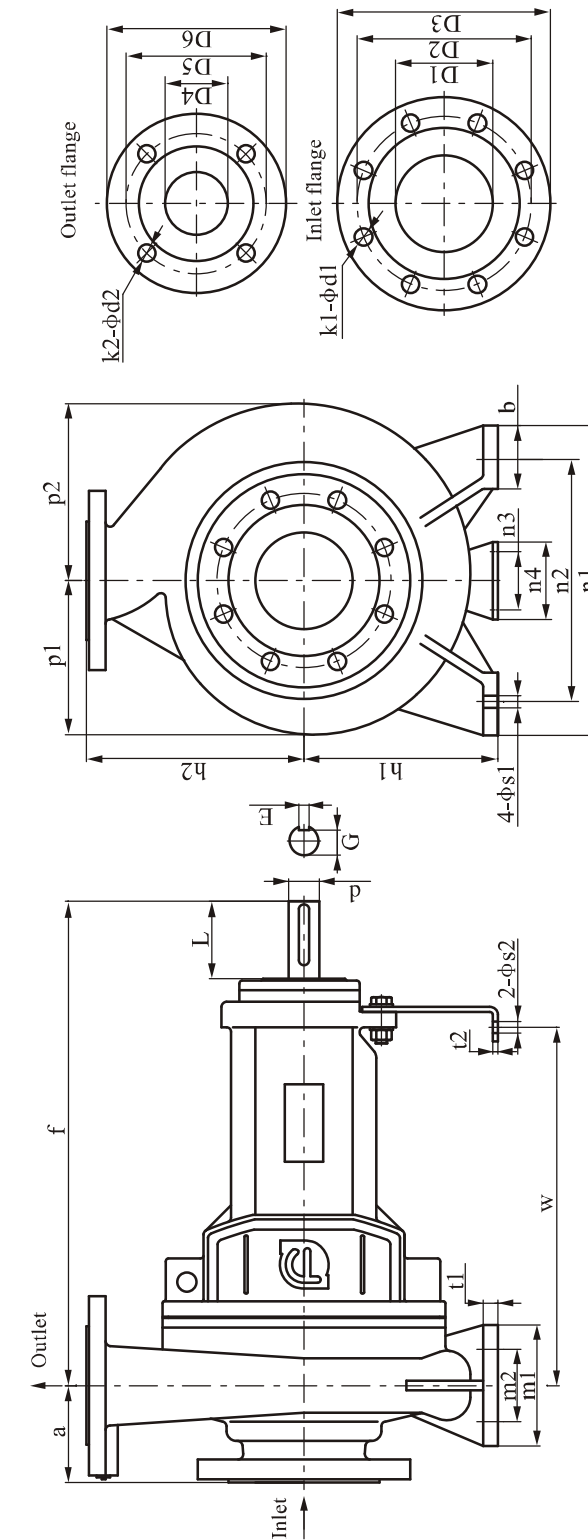

## ● Pump dimension table

No.	Model	Pump size							Installation dimension										
		a	f	h1	h2	b	p1	p2	m1	m2	n1	n2	n3	n4	t1	t2	w	s1	s2
1	50-32-160	80	385	132	160	50	118	128	100	70	240	190	110	160	12	6	285	14	14
2	50-32-200	80	385	160	180	50	139	147	100	70	240	190	110	160	12	6	285	14	14
3	65-50-160	80	385	132	160	50	121	136	100	70	240	190	110	160	12	6	285	14	14
4	65-40-200	100	385	160	180	50	140	151	100	70	265	212	110	160	13	6	285	14	14
5	65-40-250	100	500	180	225	65	166	176	125	95	320	250	110	160	14	6	370	14	14
6	65-40-315	125	500	200	250	65	194	200	125	95	345	280	110	160	16	6	370	14	14
7	80-65-160	100	385	160	180	50	124	143	100	70	265	212	110	160	13	6	285	14	14
8	80-50-200	100	385	160	200	52	147	161	100	70	265	212	110	160	13	6	285	14	14
9	80-50-250	125	500	180	225	65	167	179	125	95	320	250	110	160	15	6	370	14	14
10	80-50-315	125	500	225	280	65	204	215	125	95	345	280	110	160	18	6	370	14	14
11	100-65-200	100	500	180	225	65	159	183	125	95	320	250	110	160	14	6	370	14	14
12	100-65-250	125	500	200	250	80	180	201	160	120	360	280	110	160	16	6	370	18	14
13	100-65-315	125	530	225	280	80	210	228	160	120	400	315	110	160	18	6	370	18	14
14	100-80-160	100	500	160	200	65	132	160	125	95	280	212	110	160	14	6	370	14	14
15	125-80-400	125	530	280	355	80	261	279	160	120	435	355	110	160	20	6	370	18	14
16	125-100-200	125	500	200	280	80	175	210	160	120	360	280	110	160	17	6	370	18	14
17	125-100-250	140	530	225	280	80	193	225	160	120	400	315	110	160	18	6	370	18	14
18	125-100-315	140	530	250	315	80	224	250	160	120	400	315	110	160	19	6	370	18	14
19	125-100-400	140	530	280	355	100	265	287	200	150	500	400	110	160	20	6	370	18	14
20	150-125-250	140	530	250	355	80	204	244	160	120	400	315	110	160	19	6	370	18	14
21	150-125-315	140	530	280	355	100	236	271	200	150	500	400	110	160	20	6	370	22	14
22	150-125-400	140	530	315	400	100	273	301	200	150	500	400	110	160	21	6	370	22	14
23	200-150-315	160	670	315	400	82	255	304	200	150	515	450	140	180	25	10	500	22	18
24	200-150-400	160	670	315	450	82	291	330	200	150	515	450	140	180	25	10	500	22	18
25	250-200-315	180	670	315	450	82	278	344	200	150	515	450	140	180	25	10	500	22	18
26	250-200-400	180	670	380	450	82	314	367	200	150	515	450	140	180	25	10	500	22	18

## ● To be continued

No.	Model	Inlet flange size					Outlet flange size					Size of pump shaft extension				Weight (kg)
		D1	D2	D3	k1	d1	D4	D5	D6	k2	d2	D	L	E	G	
1	50-32-160	50	125	165	4	18	32	100	140	4	18	24	50	8	20	40
2	50-32-200	50	125	165	4	18	32	100	140	4	18	24	50	8	20	48
3	65-50-160	65	145	185	4	18	50	125	165	4	18	24	50	8	20	42
4	65-40-200	65	145	185	4	18	40	110	150	4	18	24	50	8	20	50
5	65-40-250	65	145	185	4	18	40	110	150	4	18	32	80	10	27	72
6	65-40-315	65	145	185	4	18	40	110	150	4	18	32	80	10	27	82
7	80-65-160	80	160	200	8	18	65	145	185	4	18	24	50	8	20	48
8	80-50-200	80	160	200	8	18	50	125	165	4	18	24	50	8	20	54
9	80-50-250	80	160	200	8	18	50	125	165	4	18	32	80	10	27	75
10	80-50-315	80	160	200	8	18	50	125	165	4	18	32	80	10	27	90
11	100-65-200	100	180	220	8	18	65	145	185	4	18	32	80	10	27	73
12	100-65-250	100	180	220	8	18	65	145	185	4	18	32	80	10	27	82
13	100-65-315	100	180	220	8	18	65	145	185	4	18	42	110	12	37	120
14	100-80-160	100	180	220	8	18	80	160	200	8	18	32	80	10	27	70
15	125-80-400	125	210	250	8	18	80	160	200	8	18	42	110	12	37	168
16	125-100-200	125	210	250	8	18	100	180	220	8	18	32	80	10	27	88
17	125-100-250	125	210	250	8	18	100	180	220	8	18	42	110	12	37	130
18	125-100-315	125	210	250	8	18	100	180	220	8	18	42	110	12	37	138
19	125-100-400	125	210	250	8	18	100	180	220	8	18	42	110	12	37	178
20	150-125-250	150	240	285	8	22	125	210	250	8	18	42	106	12	37	134
21	150-125-315	150	240	285	8	22	125	210	250	8	18	42	106	12	37	167
22	150-125-400	150	240	285	8	22	125	210	250	8	18	42	106	12	37	186
23	200-150-315	200	295	340	12	22	150	240	285	8	22	60	110	18	53	228
24	200-150-400	200	295	340	12	22	150	240	285	8	22	60	110	18	53	285
25	250-200-315	250	355	405	12	26	200	295	340	12	22	60	110	18	53	264
26	250-200-400	250	355	405	12	26	200	295	340	12	22	60	110	18	53	335

## ● Pump set dimension

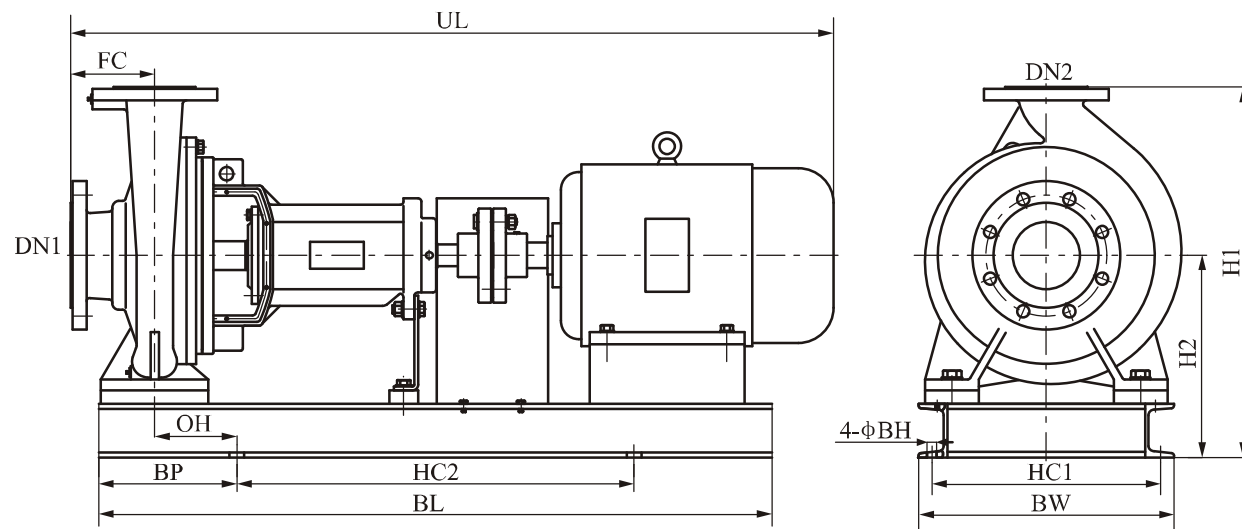

## ● Pump set dimension table

2 Pole

Model	Power (kW)	H1	H2	HC1	HC2	BW	BL	BP	BH	OH	UL	FC	DN1	DN2	Total weight (kg)
50-32-160	3	375	215	260	460	295	725	150	14	95	843	80	50	32	98
	4	375	215	260	460	295	760	150	14	95	868	80	50	32	105
	5.5	375	215	280	520	315	800	150	14	95	933	80	50	32	128
50-32-200	7.5	423	243	280	520	315	800	150	14	95	933	80	50	32	141
	11	440	260	320	600	358	900	175	18	120	1068	80	50	32	194
65-40-200	7.5	423	243	280	520	315	800	150	14	95	953	100	65	40	143
	11	440	260	320	600	358	900	175	18	120	1088	100	65	40	196
	15	440	260	320	600	358	900	175	18	120	1088	100	65	40	206
65-40-250	18.5	505	280	320	750	358	1100	200	18	130	1243	100	65	40	254
	22	525	300	360	750	402	1100	200	18	130	1293	100	65	40	297
	30	545	320	400	750	442	1200	225	18	155	1363	100	65	40	354
65-40-315	22	570	320	360	750	402	1100	200	18	130	1318	125	65	40	310
	30	570	320	400	750	442	1200	225	18	155	1388	125	65	40	363
	37	570	320	400	750	442	1200	225	18	155	1388	125	65	40	382
	45	615	365	440	800	487	1200	225	22	155	1433	125	65	40	457
65-50-160	4	375	215	260	460	295	760	150	14	95	868	80	65	50	107
	5.5	375	215	280	520	315	800	150	14	95	933	80	65	50	130
	7.5	375	215	280	520	315	800	150	14	95	933	80	65	50	133

## ● To be continued

2 Pole

Model	Power (kW)	H1	H2	HC1	HC2	BW	BL	BP	BH	OH	UL	FC	DN1	DN2	Total weight (kg)
80-50-200	11	460	260	320	600	358	900	175	18	120	1088	100	80	50	200
	15	460	260	320	600	358	900	175	18	120	1088	100	80	50	210
	18.5	460	260	320	650	358	1000	175	18	120	1128	100	80	50	231
	22	480	280	360	650	398	1000	175	18	120	1178	100	80	50	270
80-50-250	30	545	320	400	750	442	1200	225	18	155	1388	125	80	50	356
	37	545	320	400	750	442	1200	225	18	155	1388	125	80	50	375
80-50-315	37	625	345	400	750	442	1200	225	18	155	1388	125	80	50	393
	45	645	365	440	800	487	1200	225	22	155	1433	125	80	50	463
	55	675	395	500	850	547	1300	250	22	180	1538	125	80	50	562
	75	725	445	550	900	602	1350	250	22	180	1613	125	80	50	727
80-65-160	5.5	423	243	280	520	315	800	150	14	95	953	100	80	65	138
	7.5	423	243	280	520	315	800	150	14	95	953	100	80	65	141
	11	440	260	320	600	358	900	175	18	120	1088	100	80	65	194
	15	440	260	320	600	358	900	175	18	120	1088	100	80	65	204
100-65-200	18.5	505	280	320	750	358	1100	200	18	130	1243	100	100	65	254
	22	525	300	360	750	402	1100	200	18	130	1293	100	100	65	297
	30	545	320	400	750	442	1200	225	18	155	1363	100	100	65	354
100-65-250	37	545	320	400	750	442	1200	225	18	155	1363	100	100	65	373
	45	615	365	440	800	487	1250	225	22	135	1433	125	100	65	459
100-65-315	55	645	395	500	850	547	1350	250	22	160	1538	125	100	65	559
	75	695	445	550	900	602	1400	250	22	160	1613	125	100	65	725
100-80-160	90	725	445	550	900	602	1500	300	22	210	1693	125	100	65	803
	110	760	480	600	1000	655	1500	300	22	210	1848	125	100	65	1202
	11	460	260	320	700	358	1050	200	18	130	1203	100	100	80	220
125-100-200	15	460	260	320	700	358	1050	200	18	130	1203	100	100	80	230
	18.5	460	260	320	750	358	1100	200	18	130	1243	100	100	80	251
	22	480	280	360	750	398	1100	200	18	130	1293	100	100	80	289
	30	600	320	400	800	442	1200	225	18	135	1388	125	125	100	371
125-100-200	37	600	320	400	800	442	1200	225	18	135	1388	125	125	100	390
	45	645	365	440	800	487	1250	225	22	135	1433	125	125	100	464
	55	675	395	500	850	547	1350	250	22	160	1538	125	125	100	564
75	725	445	550	900	602	1400	250	22	160	1613	125	125	100	730	

● To be continued

2 Pole

Model	Power (kW)	H1	H2	HC1	HC2	BW	BL	BP	BH	OH	UL	FC	DN1	DN2	Total weight (kg)
125-100-250	75	725	445	550	900	602	1400	250	22	160	1658	140	125	100	769
	90	725	445	550	900	602	1500	300	22	210	1708	140	125	100	811
	110	760	480	600	1000	655	1500	300	22	210	1863	140	125	100	1210
125-100-315	90	760	445	550	900	602	1500	300	22	210	1708	140	125	100	817
	110	795	480	600	1000	655	1500	300	22	210	1863	140	125	100	1217
	132	795	480	600	1000	655	1600	300	22	210	1973	140	125	100	1273
	160	795	480	600	1000	655	1600	300	22	210	1973	140	125	100	1393

● Pump set dimension table

4 Pole

Model	Power (kW)	H1	H2	HC1	HC2	BW	BL	BP	BH	OH	UL	FC	DN1	DN2	Total weight (kg)
50-32-160	0.55	375	215	260	420	295	670	125	14	70	748	80	50	32	80
	0.75	375	215	260	420	295	670	125	14	70	748	80	50	32	81
50-32-200	1.1	423	243	260	470	295	700	125	14	70	783	80	50	32	94
	1.5	423	243	260	470	295	700	125	14	70	808	80	50	32	101
65-40-200	1.1	423	243	280	470	315	700	125	14	70	803	100	65	40	97
	1.5	423	243	280	470	315	700	125	14	70	828	100	65	40	104
	2.2	423	243	280	460	315	725	150	14	95	863	100	65	40	111
65-40-250	3	488	263	320	550	355	860	175	14	105	978	100	65	40	143
65-40-315	4	533	283	360	550	395	900	175	14	105	1028	125	65	40	164
	5.5	533	283	360	600	395	950	175	14	105	1093	125	65	40	181
65-50-160	0.55	375	215	260	420	295	670	125	14	70	748	80	65	50	82
	0.75	375	215	260	420	295	670	125	14	70	748	80	65	50	83
	1.1	375	215	260	450	295	700	125	14	70	783	80	65	50	87
80-50-200	1.5	443	243	280	470	315	700	125	14	70	828	100	80	50	108
	2.2	443	243	280	460	315	725	150	14	95	863	100	80	50	115
	3	443	243	280	460	315	725	150	14	95	863	100	80	50	120
80-50-250	4	488	263	320	550	355	900	175	14	105	1028	125	80	50	151
	5.5	488	263	320	600	355	950	175	14	105	1093	125	80	50	172
80-50-315	5.5	605	325	360	650	398	950	175	18	105	1093	125	80	50	195
	7.5	605	325	360	650	398	950	175	18	105	1133	125	80	50	209
80-65-160	0.75	423	243	280	420	315	670	125	14	70	768	100	80	65	90
	1.1	423	243	280	470	315	700	125	14	70	803	100	80	65	95
	1.5	423	243	280	470	315	700	125	14	70	828	100	80	65	102

● To be continued

4 Pole

Model	Power (kW)	H1	H2	HC1	HC2	BW	BL	BP	BH	OH	UL	FC	DN1	DN2	Total weight (kg)
100-65-200	3	488	263	320	550	355	860	175	14	105	978	100	100	65	143
	4	488	263	320	550	355	900	175	14	105	1003	100	100	65	149
	5.5	488	263	320	600	355	950	175	14	105	1068	100	100	65	170
100-65-250	5.5	533	283	360	650	395	965	175	14	90	1093	125	100	65	182
	7.5	550	300	360	650	398	965	175	18	90	1133	125	100	65	201
100-65-315	11	605	325	400	750	438	1100	200	18	115	1258	125	100	65	291
	15	605	325	400	750	438	1150	200	18	115	1298	125	100	65	313
100-80-160	1.5	443	243	280	500	315	850	175	14	105	943	100	100	80	127
	2.2	443	243	280	550	315	860	175	14	105	978	100	100	80	134
	3	443	243	280	550	315	860	175	14	105	978	100	100	80	139
125-80-400	15	755	400	440	800	482	1150	200	18	110	1298	125	125	80	375
	18.5	755	400	440	800	482	1150	200	18	110	1348	125	125	80	409
	22	775	420	440	800	487	1200	225	22	135	1388	125	125	80	437
125-80-400	30	775	420	440	800	487	1250	225	22	135	1418	125	125	80	493
	37	775	420	440	850	487	1250	225	22	135	1468	125	125	80	549
125-100-200	4	563	283	360	550	395	900	175	14	90	1028	125	125	100	171
	5.5	563	283	360	650	395	965	175	14	90	1093	125	125	100	187
	7.5	580	300	360	650	398	965	175	18	90	1133	125	125	100	206
125-100-200	11	580	300	360	700	398	1050	200	18	115	1228	125	125	100	251
	15	605	325	400	750	438	1150	200	18	115	1313	140	125	100	321
125-100-250	11	685	370	400	750	442	1100	200	18	110	1273	140	125	100	320
	18.5	685	370	400	800	442	1150	200	18	110	1363	140	125	100	374
	22	685	370	400	750	442	1200	225	18	135	1403	140	125	100	393
125-100-315	30	705	390	400	800	447	1250	225	22	135	1433	140	125	100	458
	30	775	420	480	800	527	1250	225	22	115	1433	140	125	100	508
	37	775	420	480	850	527	1300	225	22	115	1483	140	125	100	564
125-100-400	45	795	440	500	900	552	1300	250	22	140	1508	140	125	100	626
	11	725	370	400	750	442	1100	200	18	110	1273	140	150	125	316
150-125-250	15	725	370	400	750	442	1150	225	18	135	1313	140	150	125	340
	18.5	725	370	400	800	442	1150	225	18	135	1363	140	150	125	372
	22	725	370	400	750	442	1200	225	18	135	1403	140	150	125	391

